



INSTALLATION MANUAL

Installation must be done by a professional.
 Read this manual prior to the installation.
 Always have access to this manual as well as a factory service manual.

※ Make sure the vehicle is applicable to this kit.

NAME OF PRODUCT	GT SUPERCHARGER SYSTEM
PART NUMBER	12001-AN008
APPLICATION	NISSAN FAIRLADY Z (UA-Z33 · CBA-Z33) 2002/07~2007/01
ENGINE	VQ35DE
REMARKS	<ul style="list-style-type: none"> • In order to install this kit, HKS GT Supercharger Pulley and belt are required separately. (Refer to page 39 for more details) • HKS will not be responsible for any and all damages to the vehicle's engine or other supplemental devices through the use of this product. • Engine oil's viscosity must be higher than 40. • Fuel and ignition settings are required. If neglected, the engine may be damaged.

REVISION OF MANUAL

Rev. Number	Date	Manual Number	Details
3-3.01	2016/2	E04215-N53170-00	1 st Edition

Published in February, 2016 by HKS Co., Ltd. (Unauthorized reproduction is strictly prohibited.)

INDEX

NOTICE / ATTENTION / SAFETY PRECAUTIONS.....	1
PARTS LIST	2
1. REMOVAL OF FACTORY PARTS.....	6
2. MODIFICATION, RELOCATION, & REPLACEMENT OF FACTORY PARTS	8
3. INSTALLATION OF GT SUPERCHARGER BRACKET	15
4. INSTALLATION OF IDLER PULLEY.....	18
5. INSTALLATION OF INTERCOOLER	20
6. INSTALLATION OF TRACTION FLUID TANK & CORE	23
7. INSTALLATION OF GT SUPERCHARGER	29
8. INSTALLATION OF INTERCOOLER INLET PIPE	32
9. INSTALLATION OF SUCTION PIPE.....	34
10. INSTALLATION OF INTERCOOLER OUTLET PIPE	36
11. INSTALLATION OF SUPERCHARGER PULLEY & BELT.....	39
12. REINSTALLATION OF FACTORY PARTS	41
13. FILLING TRACTION FLUID	42
14. CONFIRMATION AFTER INSTALLATION.....	43

NOTICE

This manual assumes that you have and know how to use the tools and equipment necessary to safely perform service operations on your vehicle. This manual assumes that you are familiar with typical automotive systems and basic service and repair procedures. Do not attempt to carry out the operations shown in this manual unless these assumptions are correct. Always have access to a factory service manual. To avoid injury, follow the safety precautions contained in the factory service manual.

ATTENTION

- This manual indicates items you need to pay attention to in order to install this product safely and lists precautions to avoid any possible damage and/or accidents.
- This product is an automobile part. Do not use for any other purposes.
- HKS will not be responsible for any damage caused by incorrect installation and/or use, or use after modification and/or dismantling of this product.
- This product was designed for installation on a specific factory vehicle.
- The specifications of this product are subject to change without notice.
- The instructions are subject to change without notice. Make sure to refer to the most recent instructions.

SAFETY PRECAUTIONS

The following precautions for use of this product are to prevent possible accidents and/or injuries and for proper use.



WARNING: Indicates risk of serious injury and/or possible death.



CAUTION: Indicates risk of serious injury and/or possible property damage (i.e. vehicle damage as from use of this product.).

PARTS LIST

NO.	DESCRIPTIONS	QT	REMARKS
1	GT Supercharger	1	GTS8555
2	Traction Oil Cooler	1	
3	Traction Oil Tank	1	
4	Traction Fluid	1	
5	Hose Clamp 10mm	8	
6	Hose Clamp 8mm	4	
7	Oil Tank Bracket	1	
8	Oil Cooler Bracket No.1	1	
9	Oil Cooler Bracket No.2	1	
10	Oil Filter Bracket	1	
11	Traction Hose Assembly 10mm	1	Traction filter included.
12	Traction Hose 8mm	1	
13	Corrugated Tube CTUB15	1	O.D. 19.5mm L=4000
14	S/C Bracket No.1	1	
15	S/C Bracket No.2	1	
16	S/C Bracket Spacer	1	
17	Spacer No.1	7	14mm - 6.5mm - L14.8
18	Spacer No.2	1	12mm - 6.5mm - L57.8
19	Spacer No.3	1	14mm - 6.5mm - L39.8
20	Idler Pulley No.1	1	108mm
21	Idler Pulley No.2	1	115mm - 102mm
22	Idler Pulley Bearing Assembly	1	
23	Tensioner Pulley	1	84mm
24	Tensioner Spacer	1	
25	Tensioner Shaft	1	
26	Tensioner Adjuster	1	

27	Tensioner Bolt	1	
28	Belt 6PK 1700	1	
29	Power Steering Pump Bracket Bolt	1	
30	Water Hose Bracket No.1	1	
31	Water Hose Bracket No.2	1	
32	Water Hose Bracket No.3	1	
33	Bracket CVTC Solenoid Valve	1	
34	Intercooler	1	
35	Intercooler Bracket No.1	2	
36	Intercooler Bracket No.2	1	
37	Outside Air Temperature Sensor Bracket	1	
38	I/C Inlet Hose	1	
39	I/C Inlet Pipe No.1	1	
40	I/C Inlet Pipe No.2	1	
41	I/C Outlet Hose	1	
42	I/C Outlet Pipe No.1	1	
43	I/C Outlet Pipe No.2	1	
44	Blow-off Valve	1	
45	Hose 4mm	1	L=1000
46	Joint Pipe 4mm-6mm	1	
47	Silicone Hose 35mm	2	L=70
48	I/C Inlet Pipe Bracket No.1	1	
49	I/C Inlet Pipe Bracket No.2	1	
50	Power Steering Cooler Bracket	2	
51	Joint Pipe 10mm	2	
52	Air Cleaner Assembly	1	200mm-70mm Red
53	Suction Pipe No.1	1	
54	Suction Pipe No.2	1	

55	Suction Pipe No.3	1	
56	Restrictor	1	48mm
57	S/C Inlet Gasket	2	1 piece is included with a S/C
58	Silicone Hose 70mm	6	L=60
59	Silicone Hose 60mm-70mm	1	
60	Silicone Hose 70mm-80mm	1	
61	Hose Clamp #48	1	
62	Hose Clamp #44	16	
63	Hose Clamp #36	3	
64	Hose Clamp #16	4	
65	Pop Nut	5	
66	Tie Wrap (S)	20	
67	Tie Wrap (M)	20	
68	Tie Wrap (L)	10	
69	Sponge Sheet	3	50mm x 50mm x3mm
70	Sponge	1	
71	Hose 6mm	1	L=500
72	Suction Hose	1	16mm
73	Hose Clamp 16mm	2	
74	Joint Pipe 16mm	1	
75	Corrugated Tube CTUB10	1	O.D. 14.1mm L=250
76	Corrugated Tube CTUB5	1	O.D. 7.5mm L=1000
77	Cap Bolt M4 L12	2	
78	Cap Bolt M6 L12	2	
79	Low Head Cap Bolt M6 L12	5	Included with a S/C
80	Cap Bolt M6 L15	2	
81	Cap Bolt M6 L18	4	
82	Cap Bolt M6 L20	10	

83	Cap Bolt M6 L100	3	
84	Cap Bolt M8 L15	4	
85	Cap Bolt M8 L20	3	
86	Cap Bolt M8 L25	5	
87	Cap Bolt M12 L120	1	
88	Flat Head Bolt M8 L40	3	
89	Cap BoltM8 L16	6	
90	Button Bolt M6 L15	4	
91	Button Bolt M6 L60	6	
92	Flange Bolt M6 L15	2	
93	Flange Bolt M6 L25	2	
94	Hexagon Bolt M6 L15	1	
95	Hexagon Bolt M8 L20	3	
96	Flange Nut M6	7	
97	Flange Nut M8	2	
98	Flange Nut M10	1	
99	Self-locking Nut M6	4	
100	Spacer M4	2	
101	Flat Washer M6	23	
102	Large-diameter Washer M6	13	
103	Flat Washer M12	1	
104	Flat Washer M8	21	
105	Flat Washer M10	1	
106	Spring Washer M6	4	
107	Spring Washer M8	6	
108	Installation Manual	1	
109	Instruction Manual	1	

1. REMOVAL OF FACTORY PARTS

- (1) Disconnect the negative cable terminal from the battery.
- (2) Remove the engine under cover.
- (3) Remove the engine cover.
- (4) Remove ①air duct, ②air cleaner, ③airflow meter, and ④air hose.

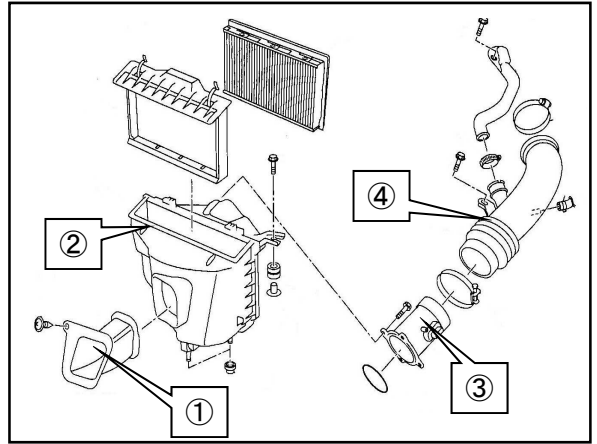

- (5) Remove ①screw, ②sensor, and ③rubber packing from the airflow meter removed in (4).

NOTE These removed parts will be used later.

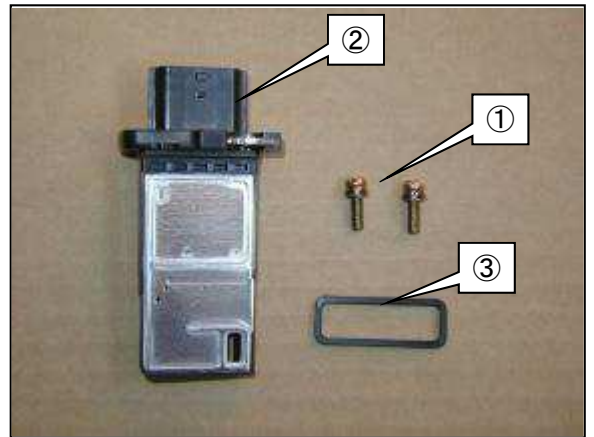

- (6) Remove the bumper.
- (7) Remove ①bumper reinforcement.
- (8) Remove ②air duct cover on the left side.

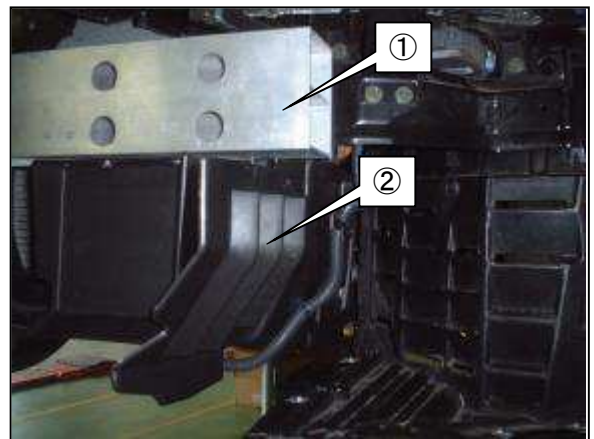

- (9) Remove ①hose clip.

NOTE

- ①hose clip will be used later.

- (10) Remove ②harness clamp and ③harness bracket.

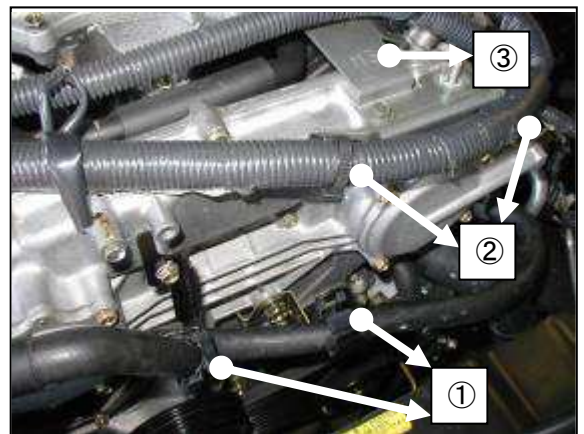

- (11) Loosen four M6 bolts of ①idler pulley.

NOTE

- Loosen the bolts before loosening the power steering pump belt.

- (12) Remove the 6-rib alternator power steering pump belt.
(13) Remove ①idler pulley.
(14) Remove two of ②bracket.
(15) Remove ③water hose clamp.

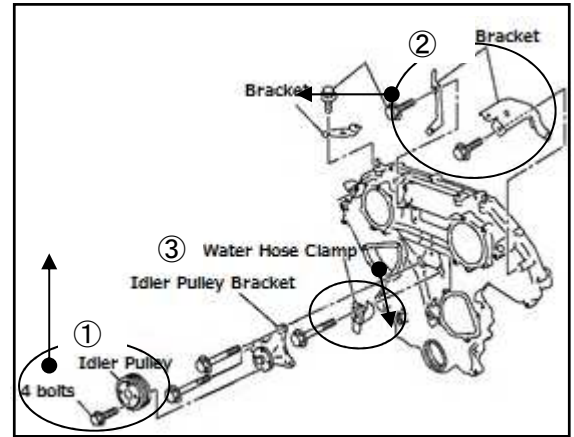

- (16) Remove ①harness clamp shown in the diagram on the right.
(17) Remove ②harness bracket shown in the diagram on the right.



2. MODIFICATION, RELOCATION, and REPLACEMENT OF FACTORY PARTS

Parts List



P20



P29



P6



P13

P11



P50



P51



P65

No.	Description	Qt
P6	Hose Clamp 10mm	4
P11	Traction Hose Assembly 10mm	1
P13	Corrugated Tube CTUB15	1
P20	Idler Pulley No.1	1
P29	Power Steering Pump Bracket Bolt	1
P50	Power Steering Cooler Bracket	2
P51	Joint Pipe 10mm	2
P65	Pop Nut	5

(1) Remove two horns.

NOTE

- When reinstalling these horns, mark the terminal and coupler to reinstall them in a proper direction. Improper installation may cause a fuse flow due to overcurrent

(2) Change the direction of ①bracket and ②terminal.

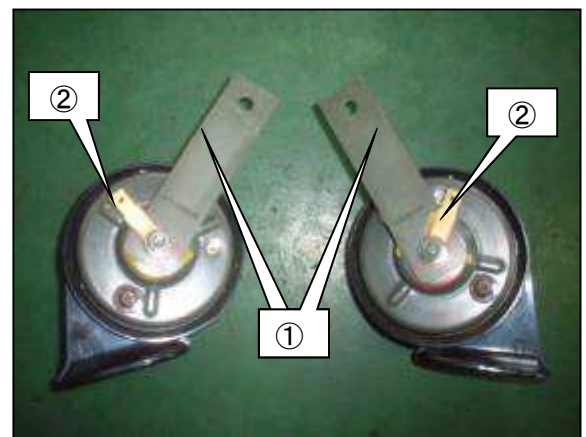

(3) Replace the factory bolt of ①power steering pump bracket with the following provided part.

- Power Steering Pump Bracket (P29)

Tightening Torque N·m(kgf·m)

T=53.9(5.5)

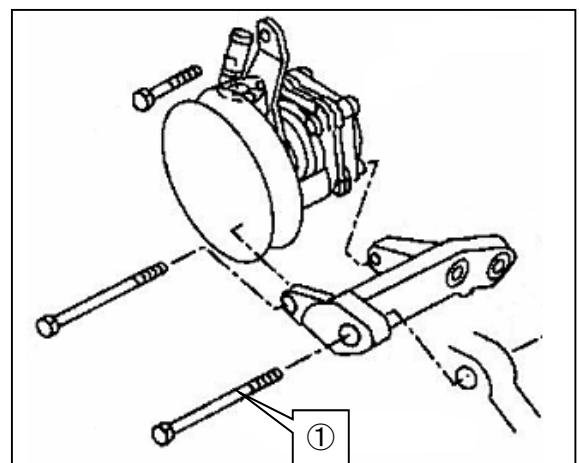

(4) Temporarily install Idler Pulley No.1 to the position where the idler pulley was removed in 1.(13).

- Idler Pulley No.1 (φ 108) (P20)
- Factory Bolt



(5) Remove ①harness cover from ①harness.

(6) Remove ③coupler from the vehicle.

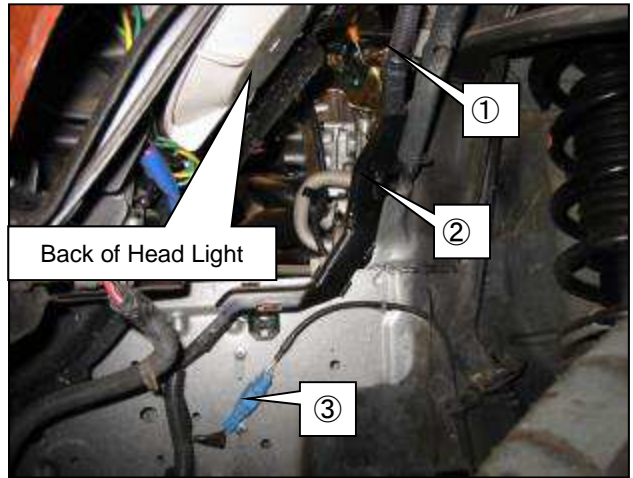
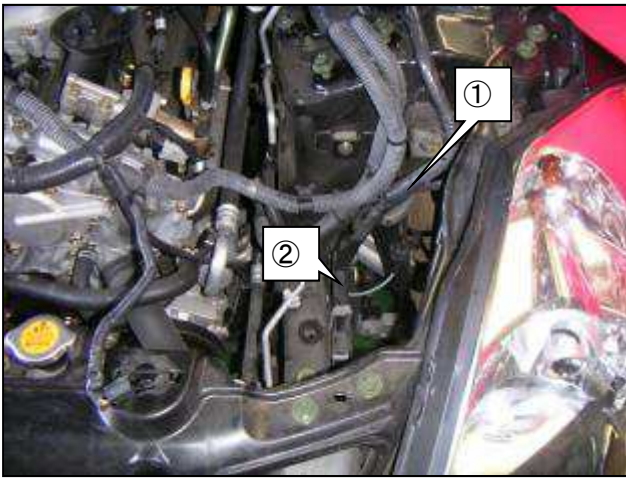

(7) Wrap ①factory harness with the provided Corrugated Tube and secure it to the panel below the left head light.

- Corrugated Tube (P75)
- Tie Wrap (L) (P68)
- Tie Wrap (M) (P67)
- Tie Wrap (S) (P66)

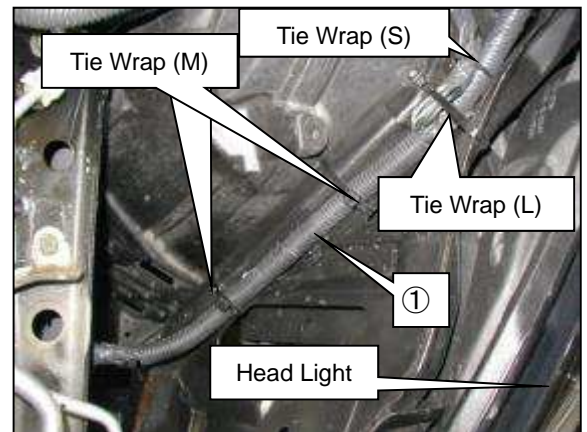

(8) Remove ①factory harness clip.

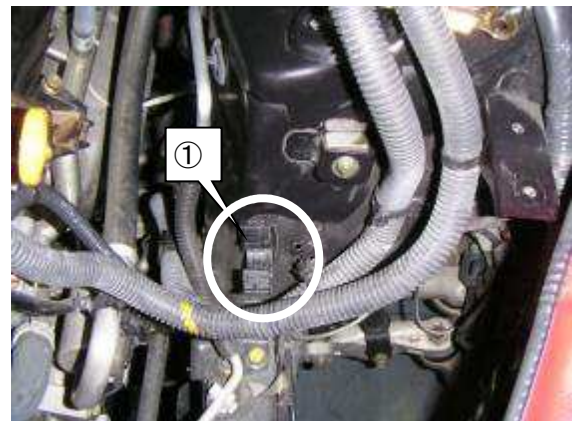

(9) Remove ①harness' clamp shown in the diagram.

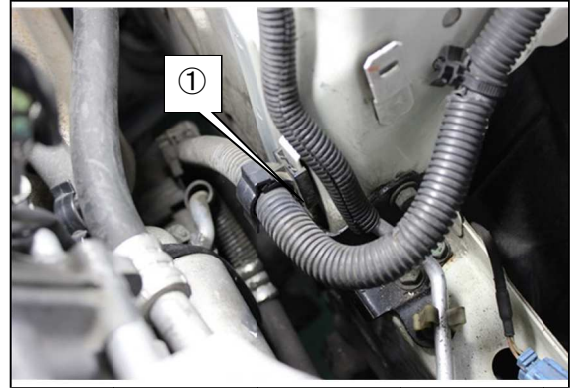

(10) Remove ①A/C pipe' clamp shown in the diagram.



(11) Bend ①A/C pipe removed from the clamp in (10) in the direction indicated by arrows shown in the diagram. Wrap the pipe with the provided Corrugated Tube.

- Corrugated Tube (P76)

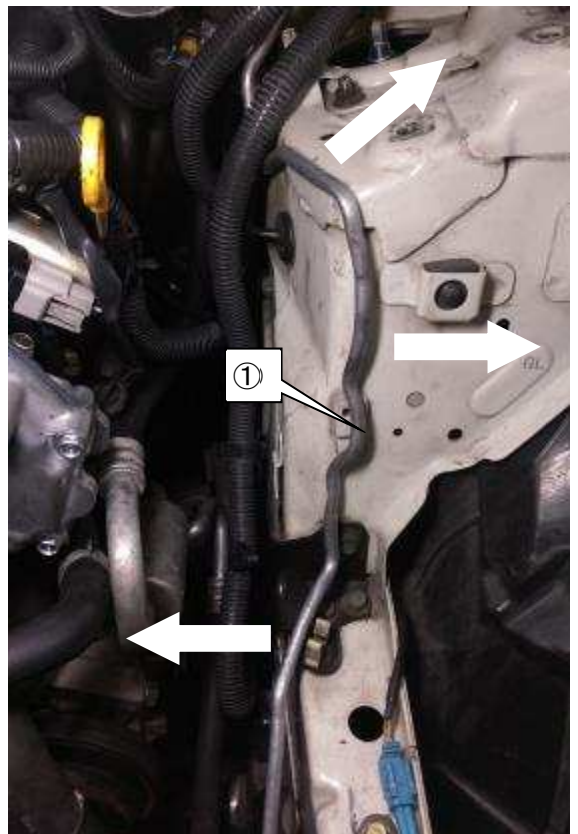

- (12) Bend ①A/C pipe in the direction indicated by arrows shown in the diagram



- (13) Remove the harness, connector, and sensor from the circles shown in the diagram.



- (14) Cut off the part at the dot line ① shown in the diagram.

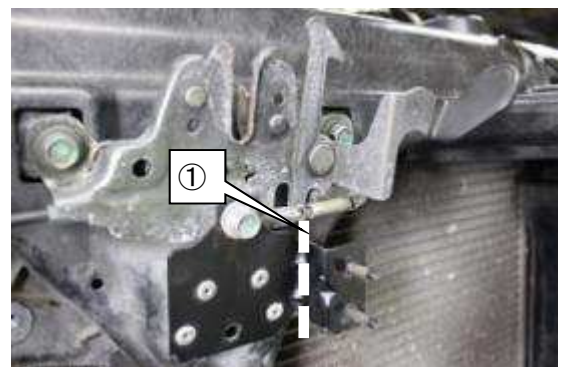

(15) Install the provided Pop Nuts to the bumper reinforcement removed in 1.(7).
Install the Pop Nuts to 4 positions (①) shown below. Make sure to install nuts to the positions indicated below:

- Pop Nut x 4 (P65)

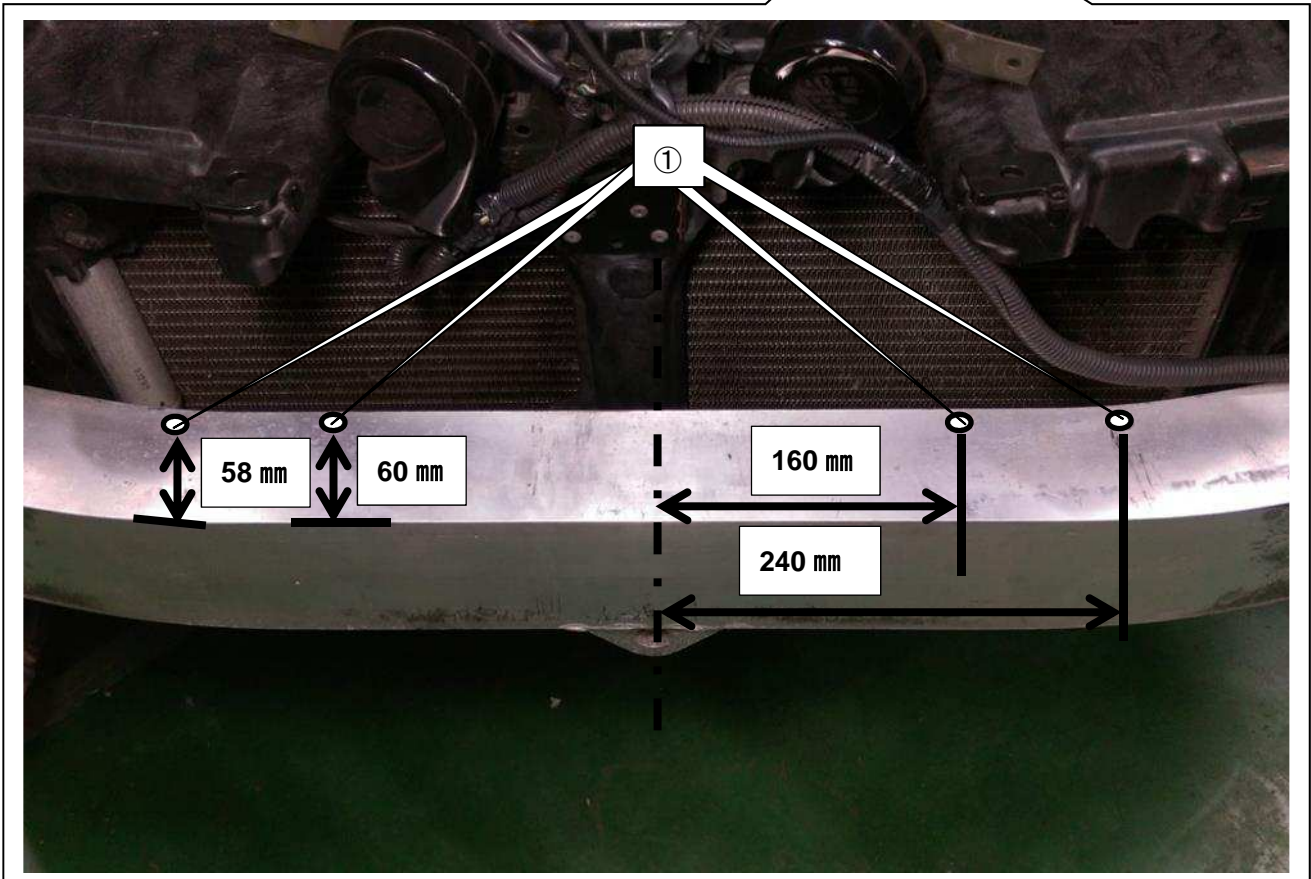
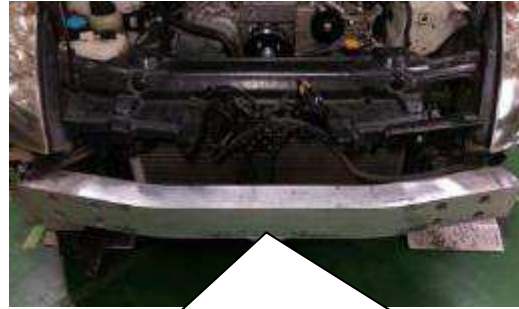

(16) Install the provided POP Nut to ① on the back of the bumper reinforcement shown in the diagram.

- Pop Nut (P65)

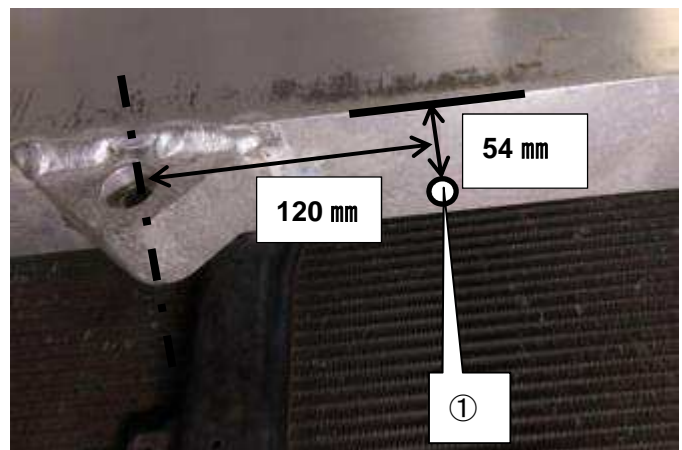

(17) Remove ① radiator reservoir tank.

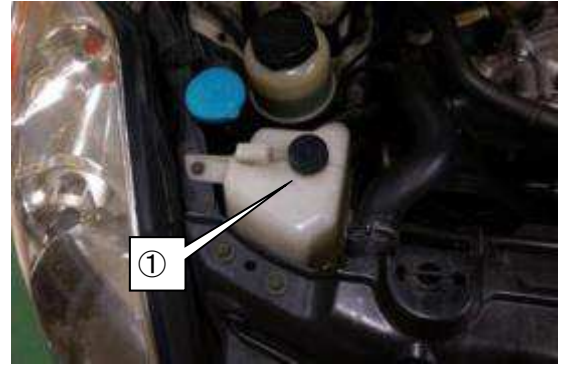

(18) Remove the P/S cooler pipes from the position indicated by arrows, and remove the P/S cooler from the vehicle.



(19) Cut the provided Traction Hose Assy 10mm (②) to 2 of 240mm hoses. Install the provided Hose Clamp 10mm (①) and Joint Pipe 10mm (③) to each hose.

- Hose Clamp 10mm (P6 x 4)
- Traction Hose Assy 10mm (P11)
- Joint Pipe 10mm (P51 x 2)

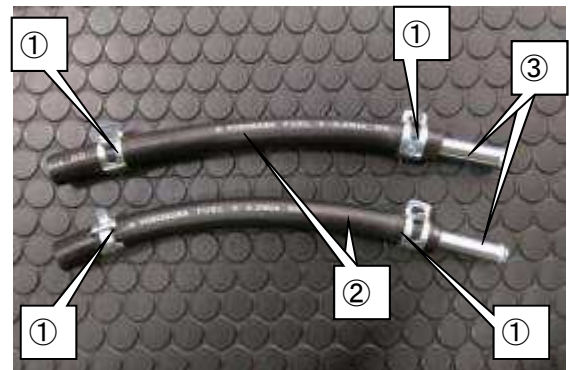

(20) Install those assembled traction hoses (②) to the P/S hoses (①) removed in (18). Cut the provided Corrugated Tube to appropriate lengths and wrap the Traction Hoses with the tubes.

- Corrugated Tube CTUB15 (P13)

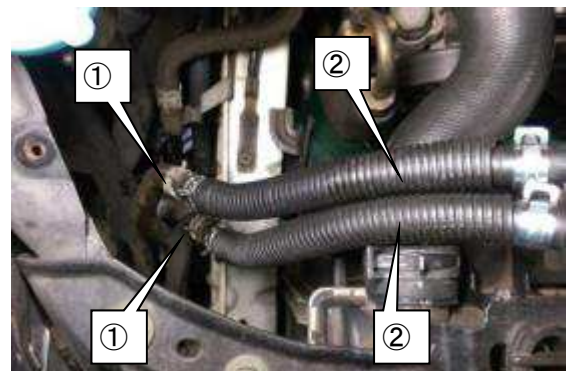

(21) Install ② Flange Bolts and ③ Flange Nuts to the provided Power Steering Cooler Bracket (①).

- Power Steering Cooler Bracket (P50 x 2)
- Flange Bolt M6 L25 (P93 x 2)
- Flange Nut M6 (P96 x 2)

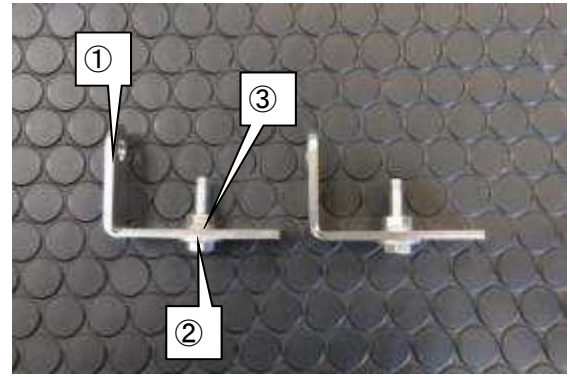

(22) Install ② Power Steering Cooler Bracket assembled in (21) and ③ factory bracket to ① P/S cooler pipe removed in (18) using ④ Self-Lock Nut, ⑤ Large-diameter Washer M6, and ⑥ Spring Washer as shown in the diagrams shown on the right.

- Self-Lock Nut M6 (P99 x 2)
- Large-diameter Washer M6 (P102 x 2)
- Spring Washer M6 (P106x2)

Tightening Torque N·m (kgf·m) T=9.5(0.97)

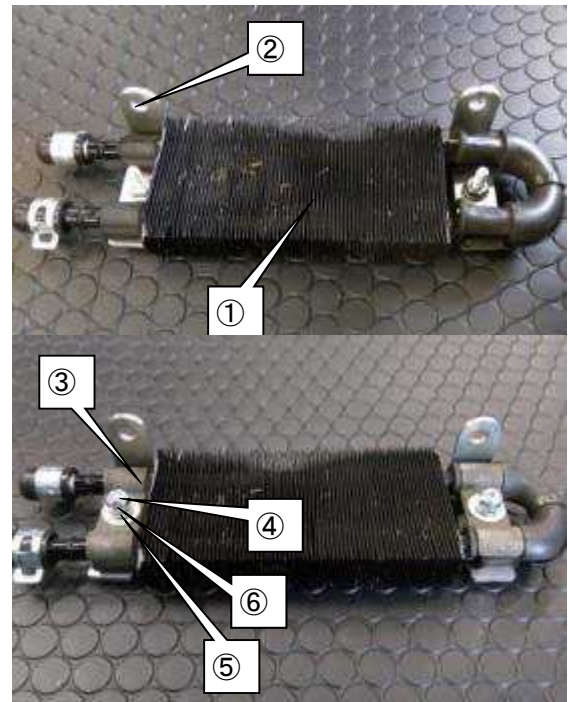

(23) Route ① P/S Cooler Hose through the hole "A" in the radiator core support and ② Power Steering Cooler assembled in (22).

(24) Install the radiator reservoir tank.

(25) Install the bumper reinforcement.

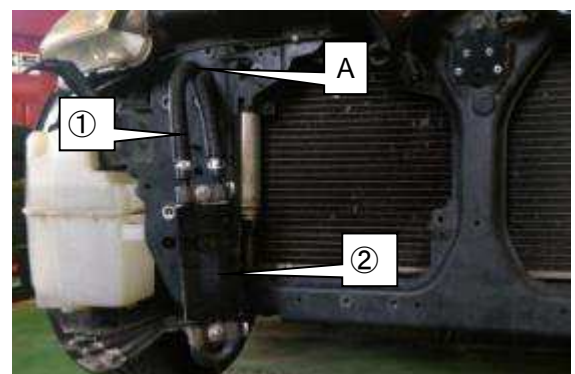
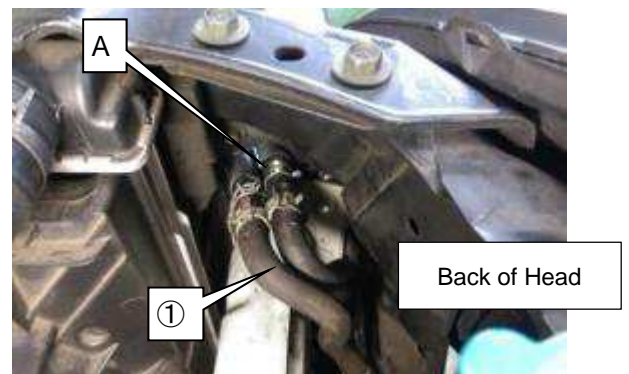

3. INSTALLATION OF SUPERCHARGER BRACKET



Parts List

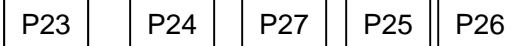
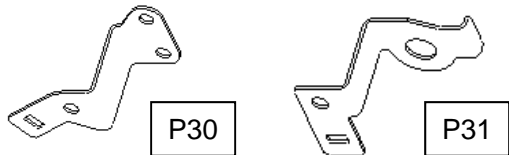
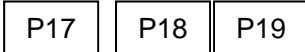
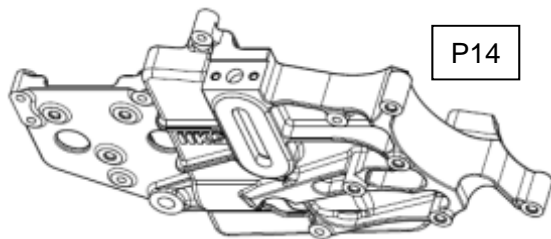

No.	Description	Qt
P14	S/C Bracket No.1	1
P17	Spacer No.1 (φ14 - φ6.5 - L14.8)	7
P18	Spacer No.2 (φ12 - φ6.5 - L57.8)	1
P19	Spacer No.3 (φ14 - φ6.5 - L39.8)	1
P23	Tensioner Pulley (φ84)	1
P24	Tensioner Spacer	1
P25	Tensioner Shaft	1
P26	Tensioner Adjuster	1
P27	Tensioner Bolt	1
P30	Water Hose Bracket No.1	1
P31	Water Hose Bracket No. 2	1
P83	Cap Bolt M6 L100	3
P87	Cap Bolt M12 L120	1
P90	Button Bolt M6 L15	2
P91	Button Bolt M6 L60	6
P98	Flange Nut M10	1
P101	Flat Washer M6	9
P105	Flat Washer M10	1
P103	Flat Washer M12	1

(1) Press-fit the Supercharger Bracket No.1 to the Spacers.

- S/C Bracket No.1 (P14)
- Spacer No.1 (14mm - 6.5mm - L14.8) (P17x7)
- Spacer No.2 (12mm - 6.5mm - L57.8) (P18)
- Spacer No.3 (14mm - 6.5mm - L39.8) (P19)

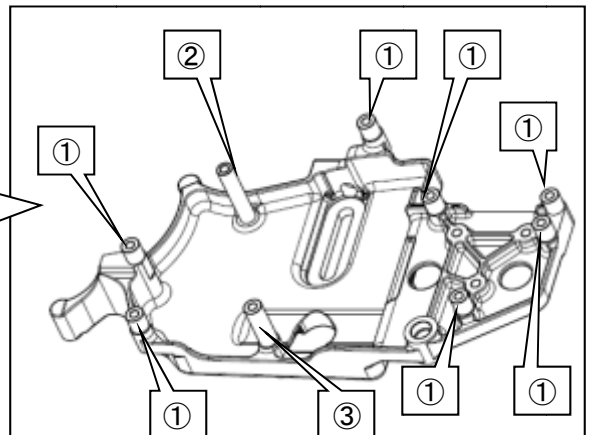
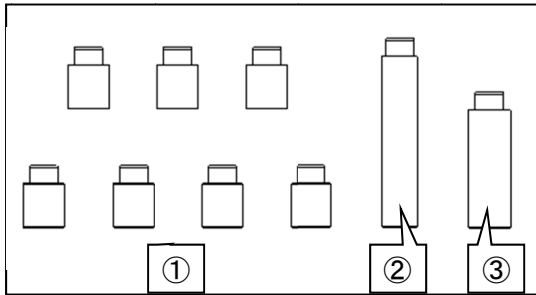

(2) Install ①Tensioner Shaft, ②Tensioner Bolt, and ③ Tensioner Adjuster.

- Tensioner Shaft (P25)
- Tensioner Adjuster (P26)
- Tensioner Bolt (P27)
- Button Bolt M6 L15 (P90 x 2)

(3) Temporarily install ④ Tensioner Spacer and ⑤ Tensioner Pulley to ①Tensioner Shaft.

- Tensioner Pulley (84mm) (P23)
- Tensioner Spacer (P24)
- Flange Nut M10 (P98)
- Flat Washer M10 (P105)

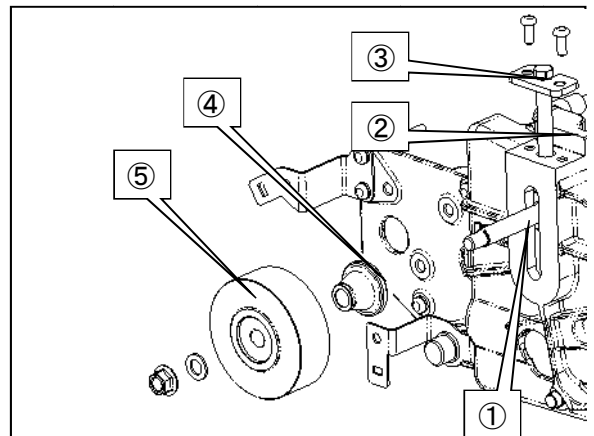

(4) Remove 10 of the factory bolts indicated by arrows in the diagram.

NOTE

- For the 35th anniversary model and vehicle equipped with a manual transmission registered after November, remove bolts in the same locations.



- (5) Install the Supercharger Bracket No. 1 to the engine.
To install the bracket, tighten ① bolt together with Bracket No.6, and ④ bolt together with the Bracket No.7.

Water Hose Bracket No.1 (P30)

- Water Hose Bracket No.2 (P31)
- Cap Bolt M6 L100 (P83x3)
- Cap Bolt M12 L120 (P87)
- Button Bolt M6 L60 (P91x6)
- Flat Washer M6 (P101x9)
- Flat Washer M12 (P103)

①・② in Diagram
(Button Bolt M6 L60 & Flat Washer M6)
Tightening Torque N·m(kgf·m)
T=11.7~13.7(1.2~1.4)

③ in Diagram
(Cap Bolt M6 L100 & Flat Washer M6)
Tightening Torque N·m(kgf·m)
T=11.7~13.7(1.2~1.4)

④ in Diagram
(Cap Bolt M12 L120 & Flat Washer M12)
Tightening Torque N·m(kgf·m)
T=68.6~79.4(7.0~8.1)

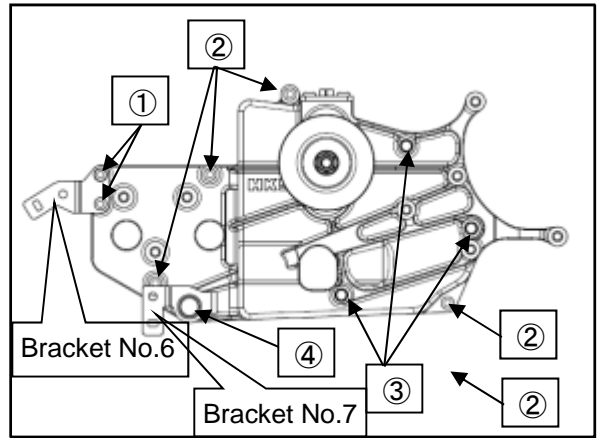

4. INSTALLATION OF IDLER PULLEY

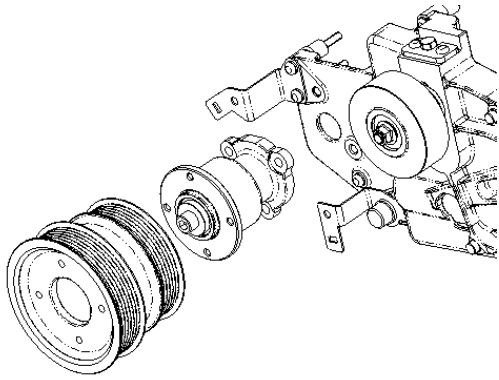

Parts List

No.	Description	Qt
P21	Idler Pulley No.2 (115mm-102mm)	1
P22	Idler Pulley Bearing Assy	1
P28	Belt 6PK 1700	1
P32	Water Hose Bracket No.3	1
P95	Hexagon Bolt M8 L20	3
P78	Cap Bolt M6 L12	2
P81	Cap Bolt M6 L18	4
P96	Flange Nut M6	2
P101	Flat Washer M6	6
P104	Flat Washer M8	3

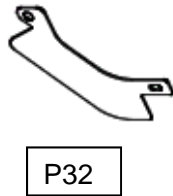

- (1) Place ② Idler Pulley No.2 over ① Idler Pulley Bearing Assy, and install the bearing assy to ③ Supercharger Bracket No.1.

- Idler Pulley No.2 (115mm-102mm) (P21)
- Idler Pulley Bearing Assy (P22)
- Hexagon Bolt M8 L20 (P95×3)
- Flat Washer M8 (P104×3)

Tightening Torque N·m(kgf·m)
T=19.6~24.5(2.0~2.2)

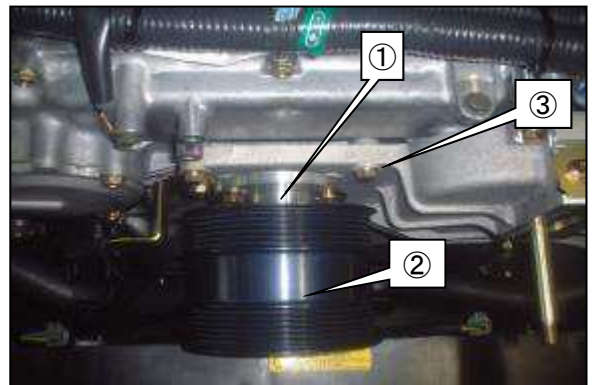

NOTE

- Idler Pulley No.2 cannot be installed if Idler Pulley Bearing Assy is installed before.

(2) Install ① Idler Pulley No.2 to the Idler Pulley Bearing Assy.

When tightening the Cap Bolt M6 L18, put an 8mm hexagon wrench on ② cap bolt M10 of the bearing assy to hold the bolt to apply the torque.

- Cap Bolt M6 L18 (P81×4)
- Flat Washer M6 (P101×4)

Tightening Torque N·m(kgf·m)

T=11.7~13.7(1.2~1.4)

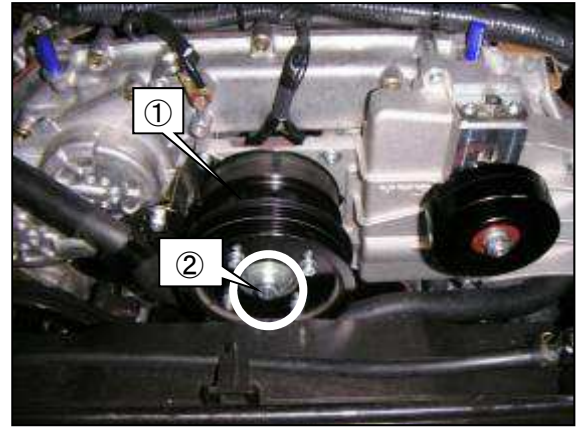

CAUTION

- Cap Bolt M6 L18 must be tightened completely at this point. If the Belt 6PK1700 is installed before tightening the bolt, the proper tightening force may become improper resulting in the damage of the bolt, and Idler Pulley No.2 may fall off.
- A torque wrench must be used to tighten the bolt. Improper tightening force may cause damage to the bolt resulting in fall-off of Idler Pulley No.2 during driving.

(3) Install ① Belt 6PK 1700 to the Idler Pulley No.2.

- Belt 6PK 1700 (P28)

NOTE

- If the water hose is secured before installing the belt, the belt cannot be installed on the Idler Pulley No.2.

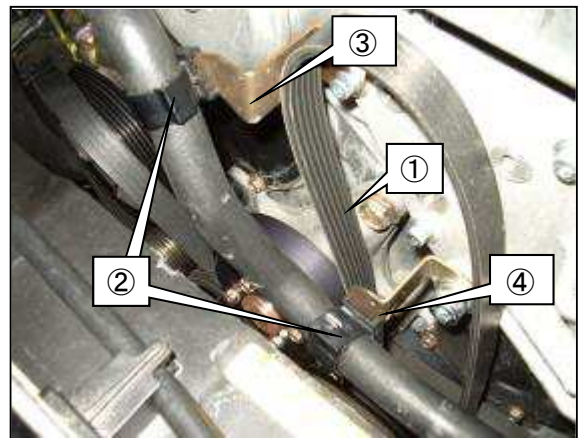

(4) Install ① Water Hose Bracket No.3.

- Water Hose Bracket No.3 (P32)
- Cap Bolt M6 L12 (P78 x 2)
- Flange Nut M6 (P96 x2)
- Flat Washer M6 (P101 x 2)

(5) Install ② water hose clips to ③ Water Hose Bracket No.1 and ④ Water Hose Bracket No.2, and secure the water hose with these clips.

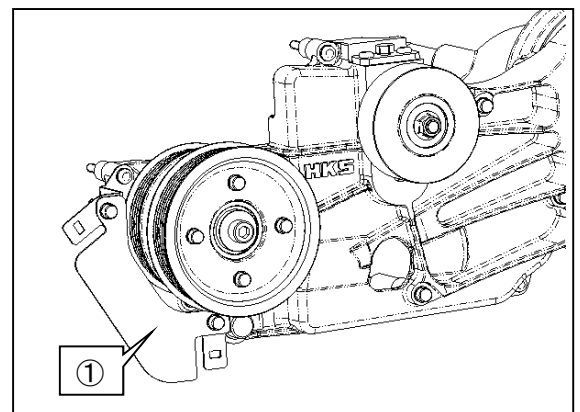

5. INSTALLATION OF INTERCOOLER

Parts List

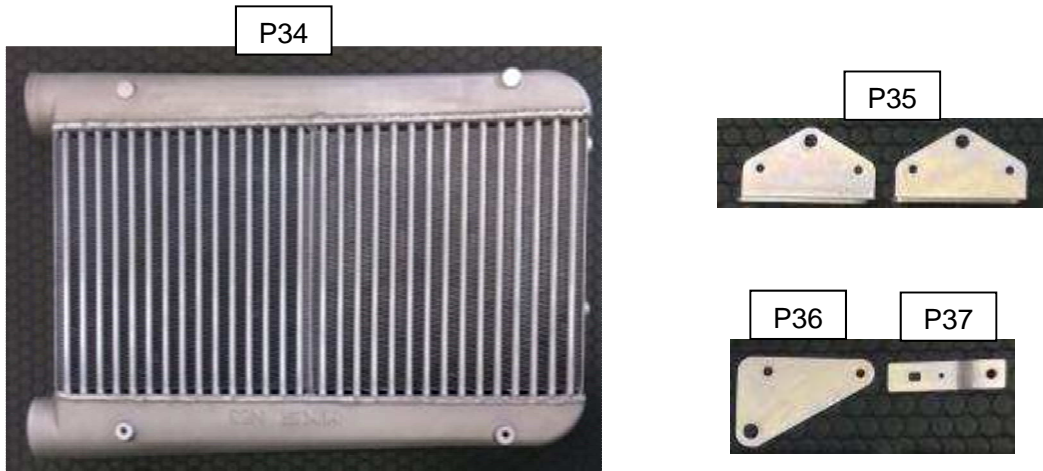

No.	Description	Qt
P34	Intercooler	1
P35	Intercooler Bracket No.1	2
P36	Intercooler Bracket No.2	1
P37	Outside Air Temperature Sensor Bracket	1
P82	Cap Bolt M6 L20	5
P89	Cap Bolt M8 L16	2
P85	Cap Bolt M8 L20	3
P90	Button Bolt M6 L15	2
P92	Flange Bolt M6 L15	2
P99	Self-Lock Nut M6	2
P102	Large-diameter Washer M6	9
P104	Flat Washer M8	5
P106	Spring Washer M6	2
P107	Spring Washer M8	2

(1) Install the provided Outside Air Temperature Sensor Bracket(②) to ① bumper reinforcement using ③ Cap Bolt and ④ Large-diameter Washer.

- Outside Air Temperature Sensor Bracket (P37)
- Cap Bolt M6 L20 (P82)
- Large-diameter Washer M6 (P102)

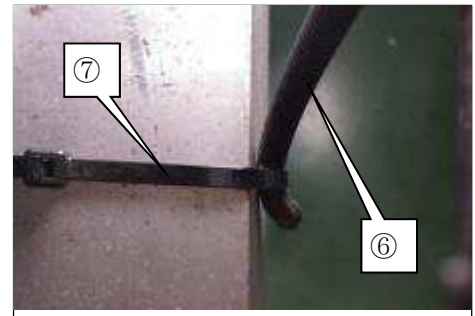

(2) Install ⑤ outside air temperature sensor to ② Outside Air Temperature Sensor Bracket. Secure ⑥ sensor harness using ⑦ Tie Wrap(L).

- Tie Wrap (L) (P68 x 2)

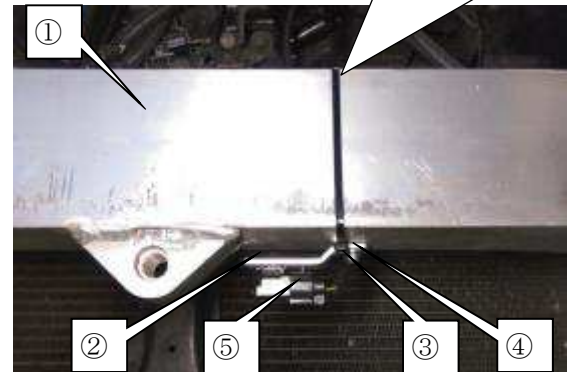

(3) Install ① Intercooler Bracket No.1 to the bumper reinforcement using ② Cap Bolt and ③ Large-diameter Washer.

- Intercooler Bracket No.1 (P35)
- Cap Bolt M6 L20 (P82x4)
- Large-diameter Washer M6 (P102x4)

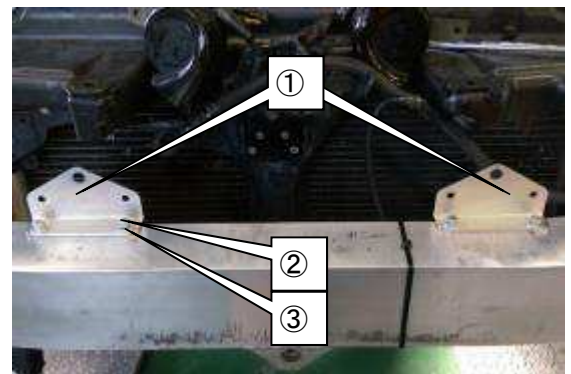

(4) Secure ② horn removed in 2.(1) to ① Intercooler Bracket No.1 using ③ Flange Bolt, ④ Large-diameter Washer, ⑤ Spring Washer, and ⑥ Self-Lock Nut.

- Flange Bolt M6 L15 (P92 x 2)
- Self-Lock Nut M6 (P99 x 2)
- Large-diameter Washer M6 (P102 x 2)
- Spring Washer M6 (P106 x 4)

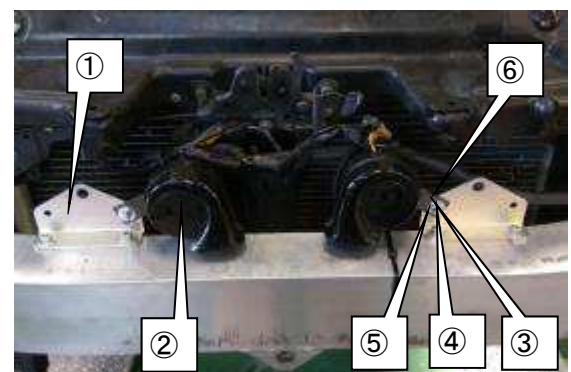

(5) Connect the harness to the horn.

(6) Secure ① Intercooler Bracket No.2 to the position shown in the diagram using ② Button Bolt and ③ Large-diameter Washer.

- Intercooler Bracket No.2 (P36)
- Button Bolt M6 L15 (P90 × 2)
- Large-diameter Washer M6 (P102 × 2)

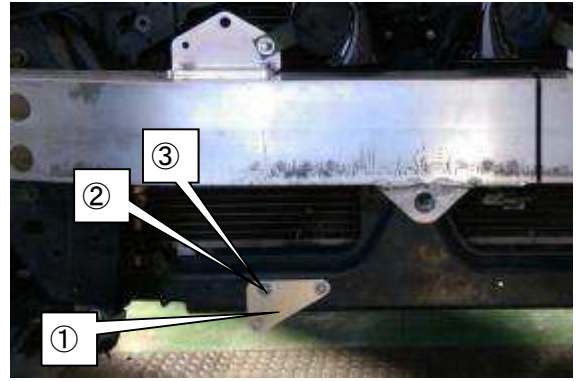

(7) Temporarily install ① Intercooler to ② Intercooler Bracket No.1 and ③ Intercooler Bracket No.2 using ④ Cap Bolts and ⑤ Washers.

- Intercooler (P34)
- Cap Bolt M8 L20 (P85 × 3)
- Flat Washer M8 (P104 × 3)

NOTE

• The boss that is located in “A” next to the intercooler must come to the lower side.

(8) Adjust the position and tighten each bolt completely.

Tightening Torque N·m(kgf·m)
 M6: T=11.5(1.2)
 M8: T=20(2.0)

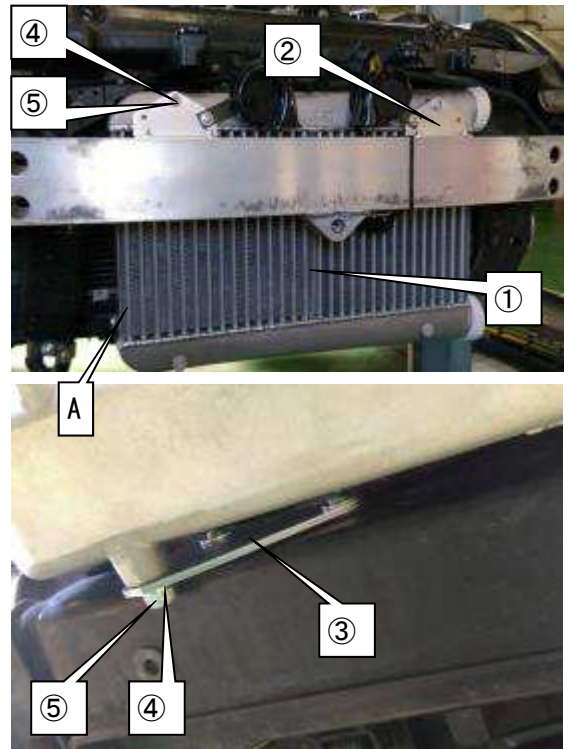

(9) Install ① power steering cooler to the Intercooler using ② Cap Bolts, ③ Spring Washers and ④ Flat Washers.

- Cap Bolt M8 L16 (P89 × 2)
- Spring Washer M8 (P107 × 2)
- Flat Washer M8 (P104 × 2)

Tightening Torque N·m(kgf·m)
 T=20(2.0)

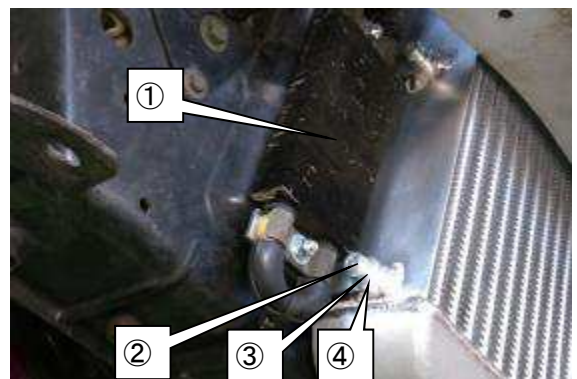

(10) Bundle the wires using the provide Tie Wrap (M).

- Tie Wrap (M) (P67 × 2)

6. INSTALLATION OF TRACTION FLUID TANK & CORE

Parts List

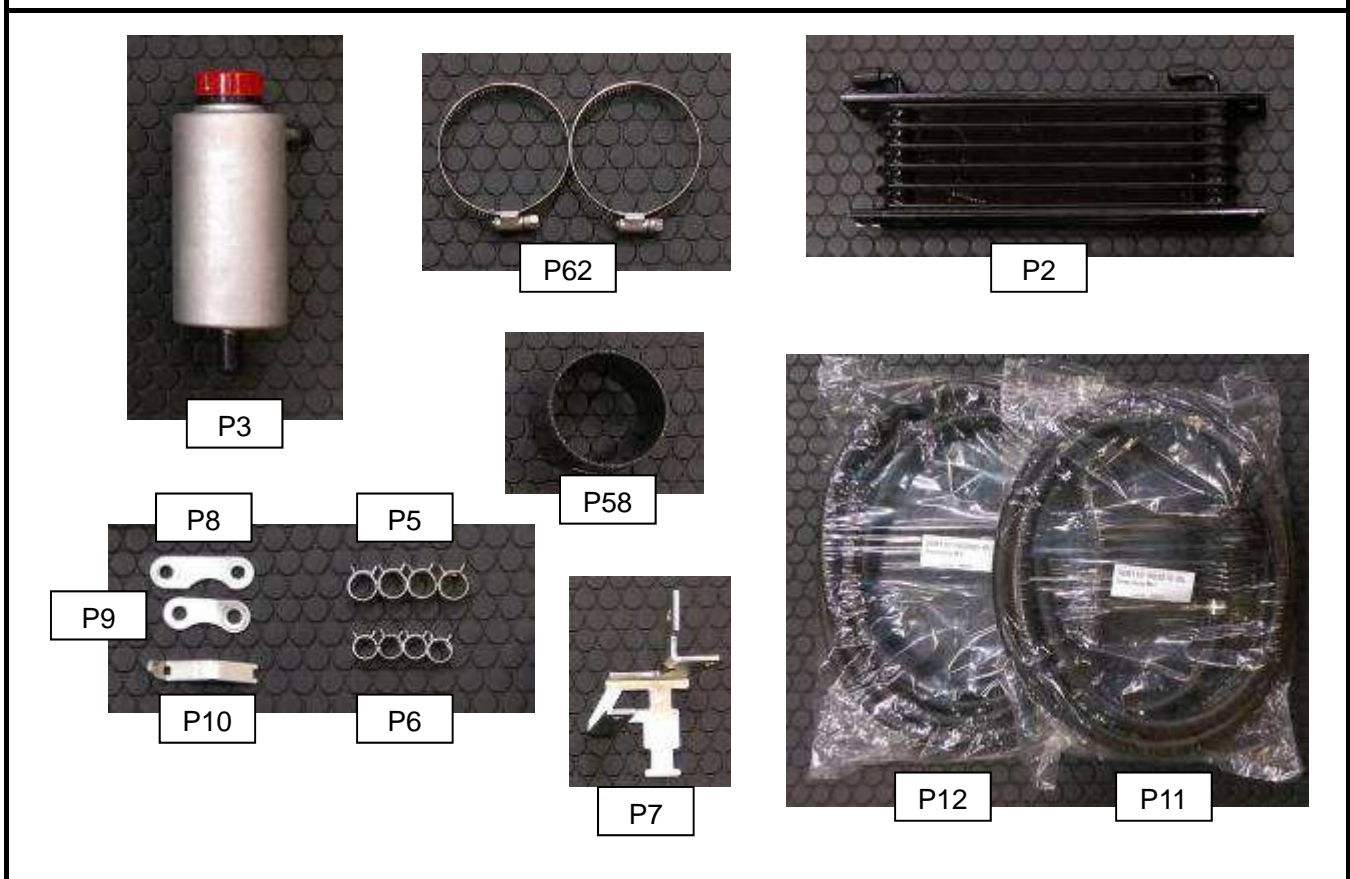

No.	Description	Qt
P2	Traction Oil Cooler	1
P3	Traction Oil Tank	1
P5	Hose Clamp 10mm	4
P6	Hose Clamp 8mm	4
P7	Oil Tank Bracket	1
P8	Oil Cooler Bracket No.1	1
P9	Oil Cooler Bracket No.2	1
P10	Oil Filter Bracket	1
P11	Traction Hose Assembly 10mm	1
P12	Traction Hose 8mm	1
P13	Corrugated Tube CTUB15	1
P58	Silicone Hose 70mm	1
P62	Hose Band #44	2
P80	Cap Bolt M6 L15	2
P89	Cap Bolt M8 L16	4
P97	Flange Nut M8	2
P101	Flat Washer M6	2
P104	Flat Washer M8	6
P107	Spring Washer M8	4

NOTE

- Do not allow foreign objects to mix with the Traction Fluid. If foreign objects mixed with Traction Fluid, it can lead to damage to the Supercharger Assy. To prevent any foreign object from entering into hoses and/or tank, plug the hose ends and adapters during the fluid piping.

○The following is the traction fluid piping diagram. Refer to this diagram to perform the procedures below. Make sure to install the parts in correct positions.

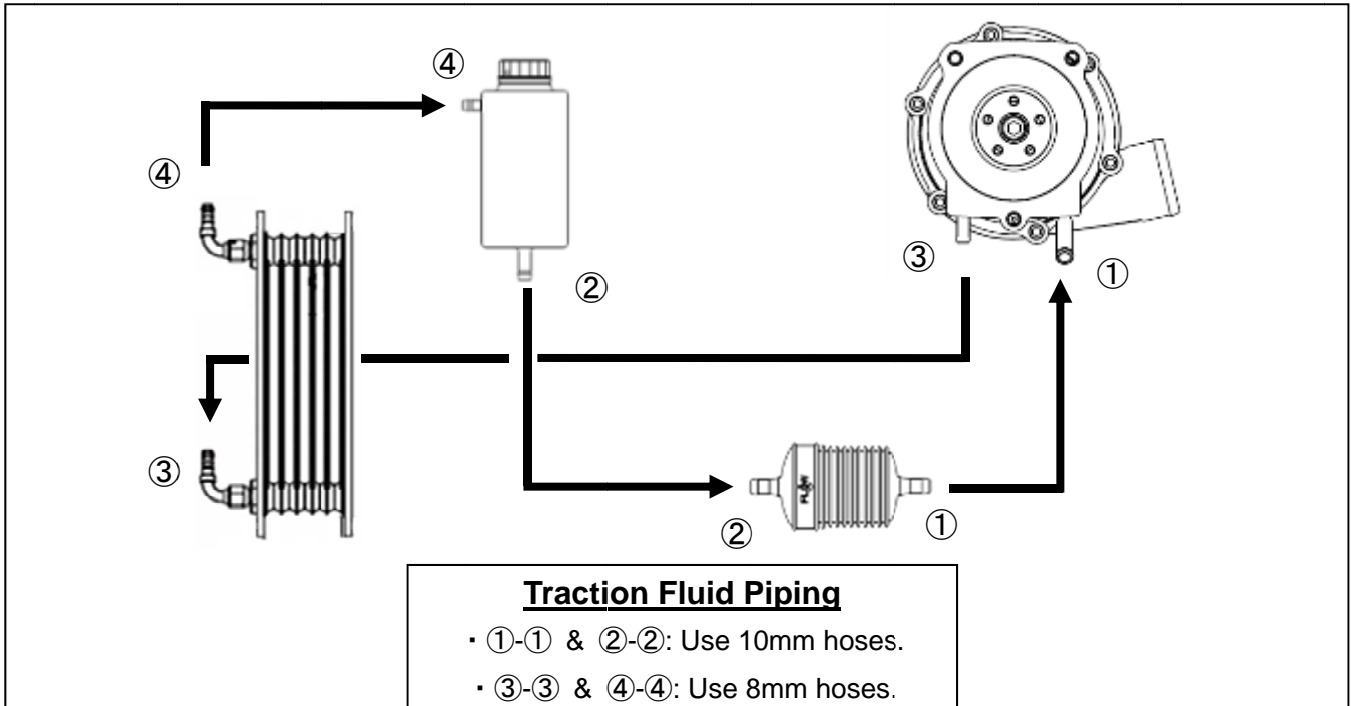

(1) Install ②Oil Cooler Bracket No.2 to ①Traction Oil Cooler.

- ①Traction Oil Cooler (P2)
- ②Oil Cooler Bracket No.2 (P9)
- ③Cap Bolt M8 L16 (P89)
- ④Spring Washer M8 (P107)
- ⑤Flat Washer M8 (P104)
- ⑥Flange Nut M8 (P97)

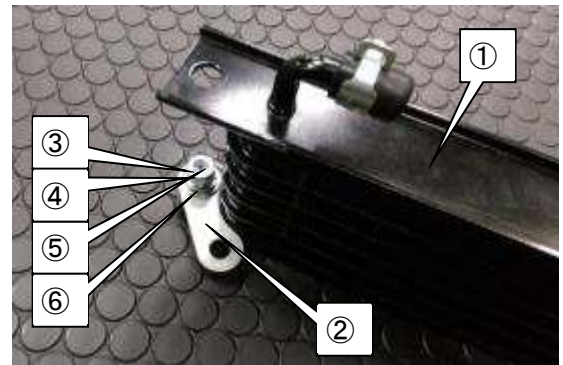

NOTE

- Make sure to install the attachment of Traction Oil Cooler in a proper direction.

(2) Install ②Oil Cooler Bracket No.1 to ①Traction Oil Cooler.

- ①Traction Oil Cooler (P2)
- ②Oil Cooler Bracket No.1 (P8)
- ③Cap Bolt M8 L16 (P89)
- ④Spring Washer M8 (P107)
- ⑤Flat Washer M8 (P104)
- ⑥Flange Nut M8 (P97)

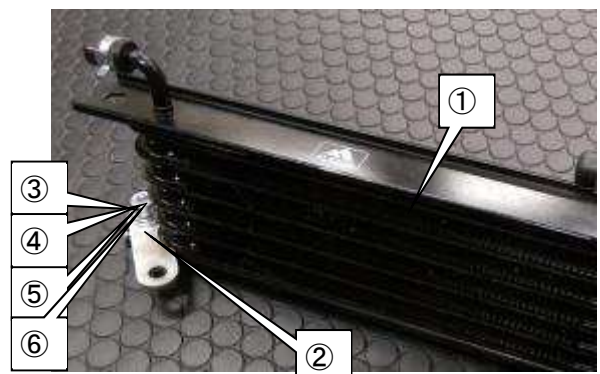

- (3) Cut off the runover "A" from the Oil Cooler Bracket No.1 along the bracket.

NOTE

- Perform the same process for the Oil Cooler Bracket No.2.

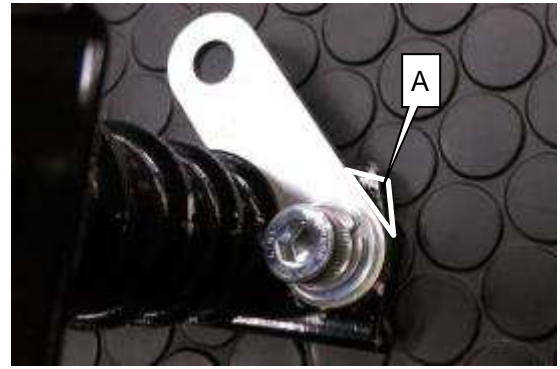

- (4) Cut the Traction Hose 8mm to 600mm and 1700mm in length.

- Traction Hose 8mm (P12)

- (5) Install ①600mm Traction Hose to ②Oil Cooler Core Assy using ③Hose Clamp 8mm (P6)

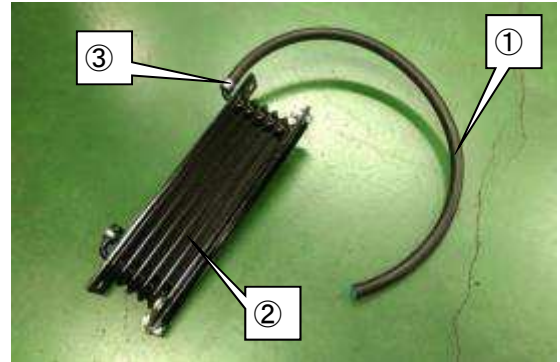

- (6) Install ①Traction Oil Cooler Core with the Traction Hose 8mm to ② Intercooler using the following provided parts.

- ③Cap Bolt M8 L16 (P89 x 2)
- ④Spring Washer M8 (P107 x 2)
- ⑤Flat Washer M8 (P104 x 4)

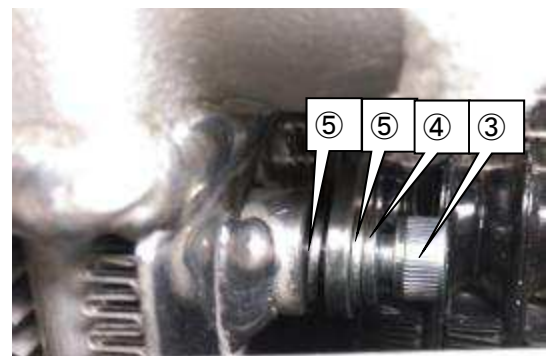
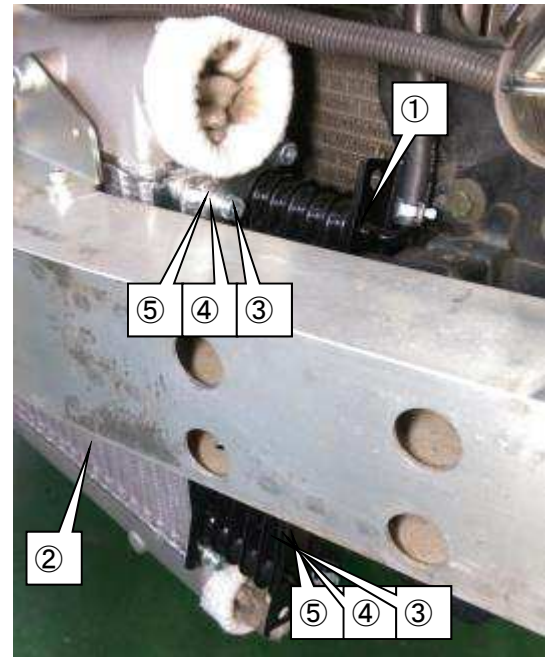

(7) Remove ① canister purge control valve with the bracket from the vehicle.



(8) Install ② Oil Tank Bracket to ① Traction Oil Tank using the following provided parts.

- ① Traction Oil Tank (P3)
- ② Oil Tank Bracket (P7)
- ③ Silicone Hose 70mm (P58)
- ④ Hose Band #44 (P62 x 2)

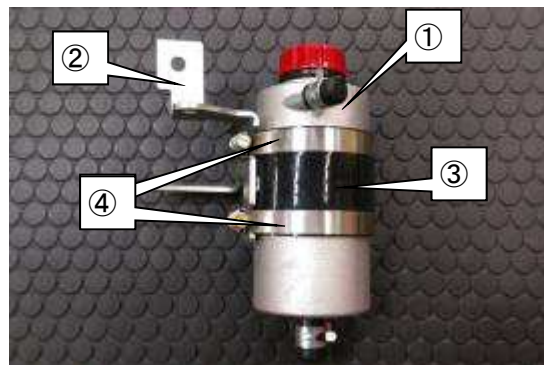

(9) Install ② canister purge control valve to ① Traction Oil Tank using a factory nut.

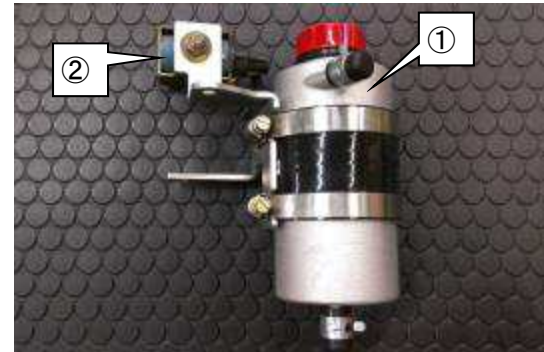

(10) Cut the Traction Hose Assy 10mm to ①130mm and ②900mm. Install these hoses to the Traction Oil Filter.

- Traction Hose Assy 10mm (P11)
- Hose Clamp 10mm (P5 x 4)

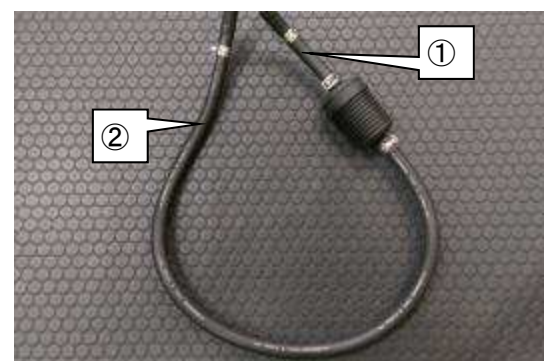

- (11) Install ②Traction Hose Assy to ①Traction Oil Tank assembled in (9).

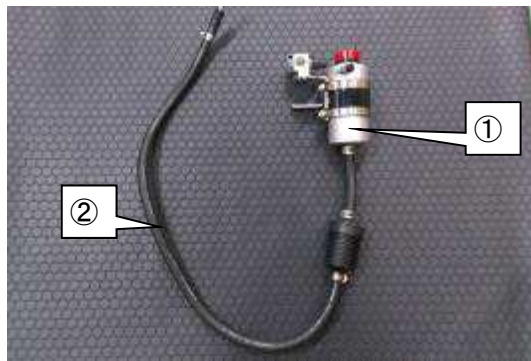

- (12) Install ①Oil Filter Bracket inside the engine bay using the following provided parts.

- ①Oil Filter Bracket (P10)
- ②Cap Bolt M6 L15 (P80)
- ③Flat Washer M6 (P101)

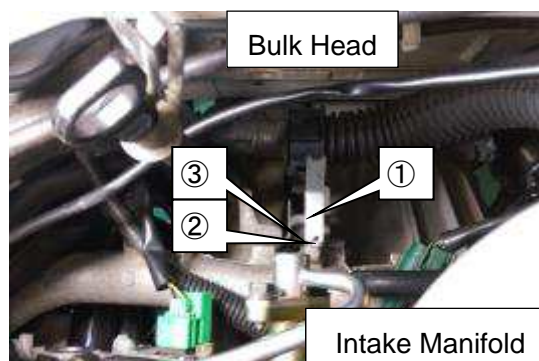

- (13) Install the Traction Oil Tank Assy to the intake manifold using the following provided parts.

- ①Cap Bolt M6 L15 (P80)
- ②Flat Washer M6 (P101)

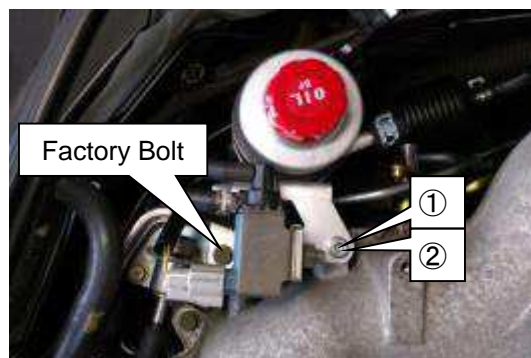

- (14) Secure ①Traction Oil Filter to ③Oil Filter Bracket using ②Tie Wrap (L).

- ②Tie Wrap (L) (P68)

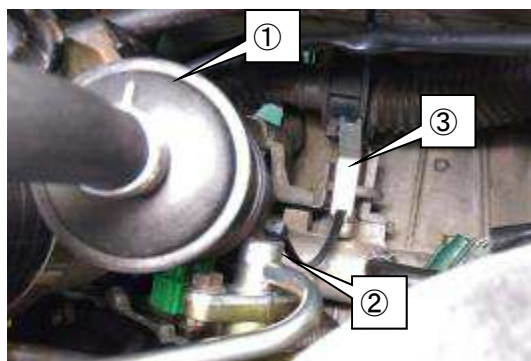

- (15) Install ② 1700mm Traction Hose 8mm to ① Traction Oil Tank Assy using ③ Hose Clamp 8mm.

• Hose Clamp 8mm (P6)

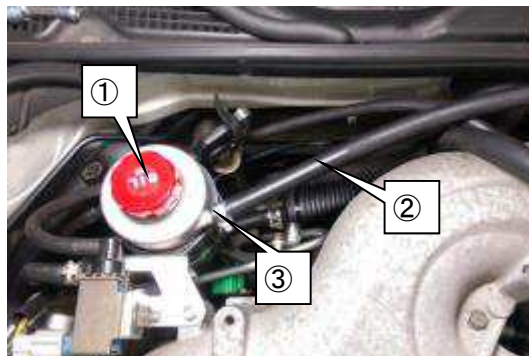

- (16) Cut the Corrugated Tube to an appropriate length, and wrap the Traction Hoses with those tubes.

• Corrugated Tube (P13)

- (17) Route the Traction Hoses installed to the Traction Oil Tank Assy under the intake manifold to the installation position of the supercharger.

- ① 600mm Traction Hose 8mm
- ② 1700mm Traction Hose 8mm
- ③ Traction Hose 10mm

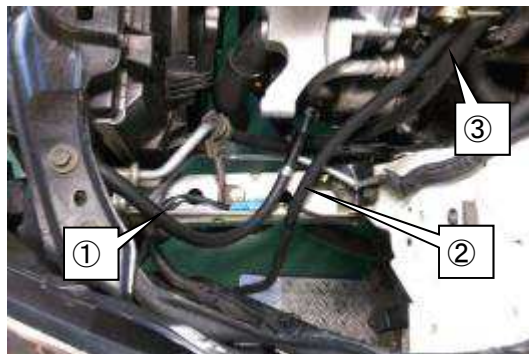
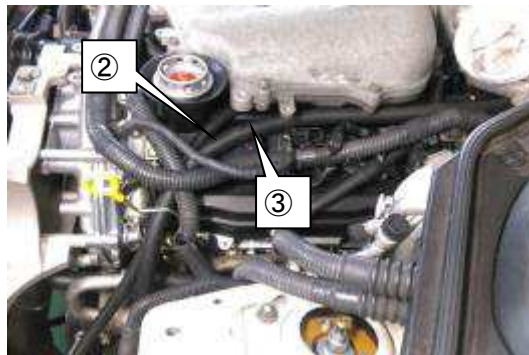

- (18) Install ② 1700mm Traction Hose 8mm to ① Traction Oil Cooler Core using ③ Hose Clamp 8mm.

• Hose Clamp 8mm (P6)

- (19) Secure the Traction Hose at 30cm interval using the provided Tie Wrap (M) to prevent the hose from coming in contact with any other parts of the vehicle.

• ① Tie Wrap (M) (P67)

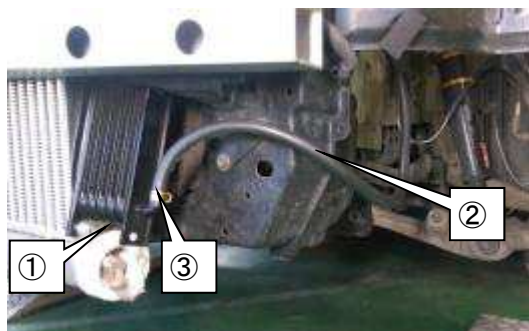

7. INSTALLATION OF SUPERCHARGER

Parts List

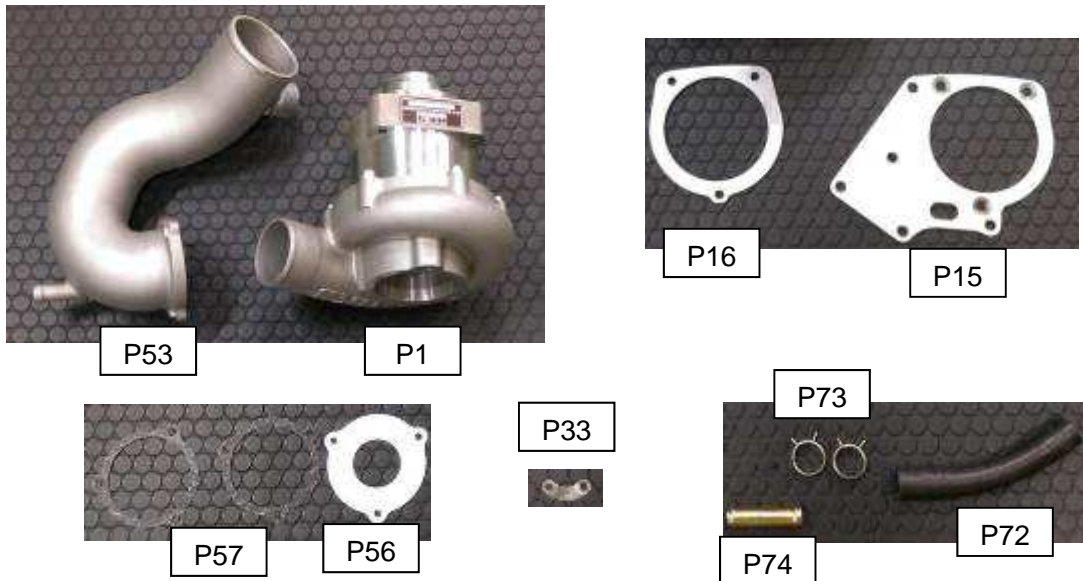

No.	Description	Qt
P1	GT Supercharger	1
P15	S/C Bracket No.2	1
P16	S/C Bracket Spacer	1
P33	Bracket CVTC Solenoid Valve	1
P53	Suction Pipe No.1	1
P56	Restrictor	1
P57	S/C Inlet Gasket	2
P72	Suction Hose	1
P73	Hose Clamp 16mm	2
P74	Joint Pipe 16mm	1
P82	Cap Bolt M6 L20	3
P86	Cap Bolt M8 L25	5
P88	Dish Bolt M8 L40	3
P94	Hexagon Bolt M6 L15	1
P96	Flange Nut M6	1
P101	Flat Washer M6	5
P104	Flat Washer M8	5

(1) Remove the installation bolt of ①CVTC solenoid. Rotate the solenoid toward the direction indicated by the arrow in the diagram. Secure the solenoid using the provided ②Bracket CVTC Solenoid Valve.

- ②Bracket CVTC Solenoid Valve (P33)
- ③Hexagon Bolt M6 L15 (P94)
- ④Flat Washer M6 (P101x2)
- ⑤Flange Nut M6 (P96)

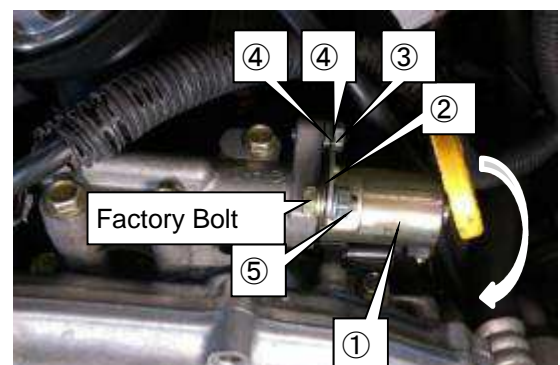

(2) Install the S/C Bracket No.2 and S/C Bracket Spacer to ①GT Supercharger using the provided Dish Bolt M8 L40.

- ②S/C Bracket No.2 (P15)
- ③S/C Bracket Spacer (P16)
- ④Dish Bolt M8 L40 (P88 × 3)

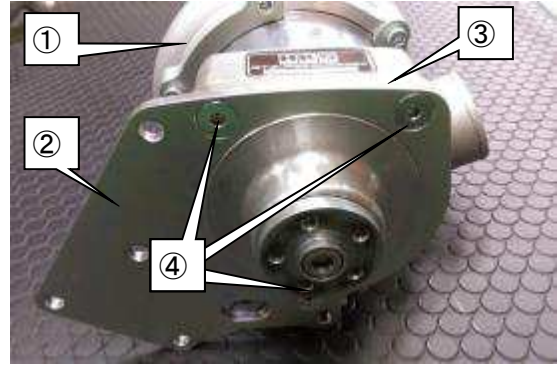

(3) Install the Suction Pipe No.1, Restrictor, and S/C Inlet Gasket to ①GT Supercharger using the provided Cap Bolt M6 L20 and Flat Washers.

- ②Suction Pipe No.1 (P53)
- ③Restrictor (P56)
- ④S/C Inlet Gasket (P57)
- ⑤Cap Bolt M6 L20 (P82 × 3)
- ⑥Flat Washer M6 (P101 × 3)

NOTE

- The restrictor is not required if the engine internals are modified to achieve the engine output 400HP or more.

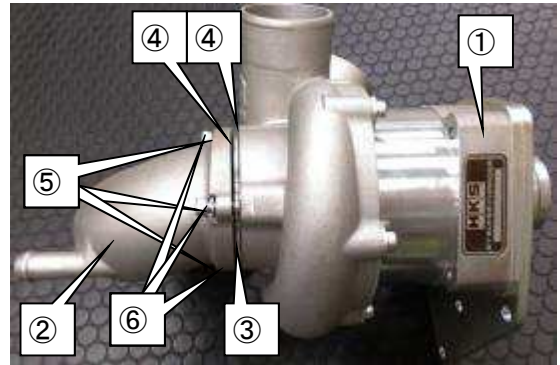

(4) Install ① 600mm Traction Hose 8mm, ② Traction Hose 10mm to GT Supercharger using the provided Hose Clamps.

- ③Hose Clamp 8mm (P6)
- ④Hose Clamp 10mm (P5)

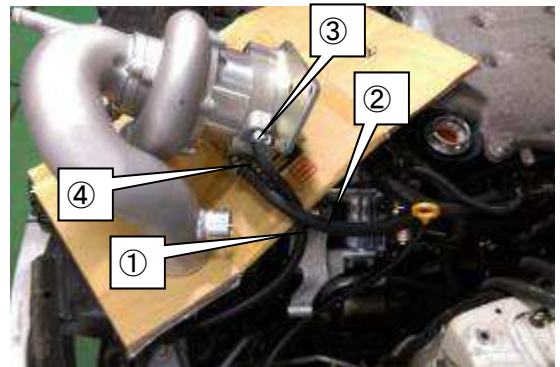

(5) Install ①GT Supercharger to ②S/C Bracket No.1 Using the following provided parts.

- ③Cap Bolt M8 L25 (P86×5)
- ④Flat Washer M8 (P104×5)

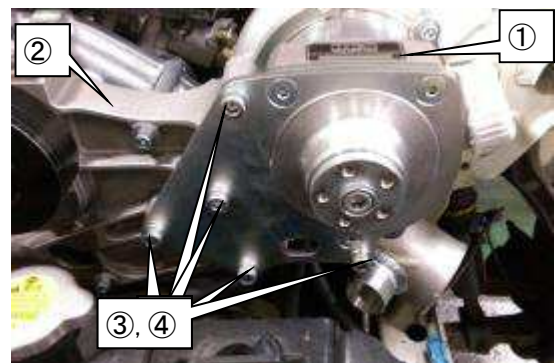

(6) Install ②Joint Pipe 16mm and ③Hose Clamp 16mm to ①Suction Hose.

- ①Suction Hose (P72)
- ②Joint Pipe (P74)
- ③Hose Clamp 16mm (P73x2)

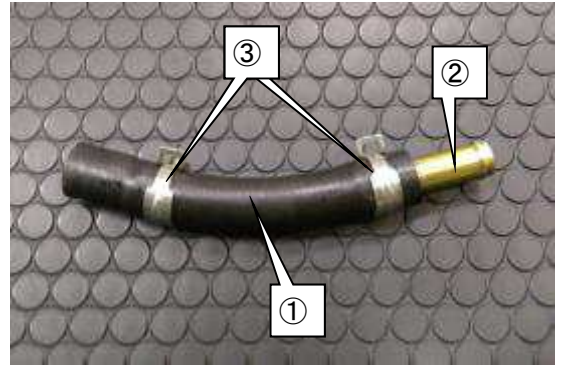

(7) Install ①Suction Hose to the factory blow-by hose (A) using a factory clamp and ②Hose Clamp 16mm.

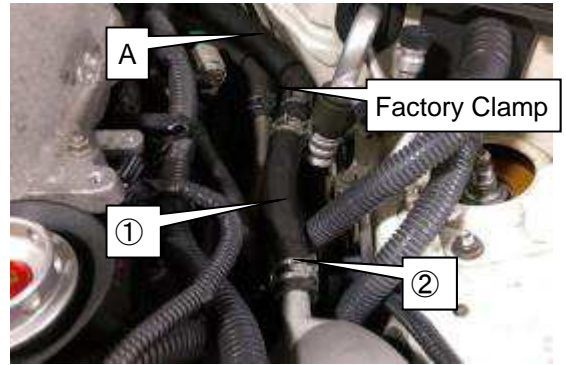

8. INSTALLATION OF INTERCOOLER INLET PIPE

Parts List

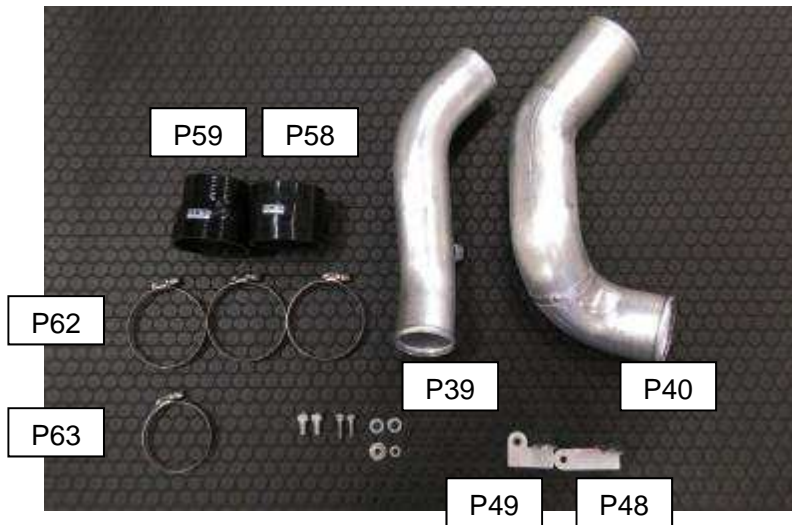

No.	Description	Qt
P39	I/C Inlet Pipe No.1	1
P40	I/C Inlet Pipe No.2	1
P48	I/C Inlet Pipe Bracket No.1	1
P49	I/C Inlet Pipe Bracket No.2	1
P58	Silicone Hose 70mm	1
P59	Silicone Hose 60mm-70mm	1
P62	Hose Band #44	3
P63	Hose Band #36	1
P82	Cap Bolt M6 L20	2
P84	Cap Bolt M8 L15	2
P101	Flat Washer M6	1
P102	Large-diameter Washer M6	1
P104	Flat Washer M8	2

(1) Install ② I/C Inlet Pipe Bracket No.1 to ① I/C Inlet Pipe No.1. Attach the Sponge Sheet as shown in the diagram on the right side.

- ① I/C Inlet Pipe No.1 (P39)
- ② I/C Inlet Pipe Bracket No.1 (P48)
- ③ Cap Bolt M8 L15 (P84)
- ④ Flat Washer M8 (P104)
- ⑤ Sponge Sheet (P69)

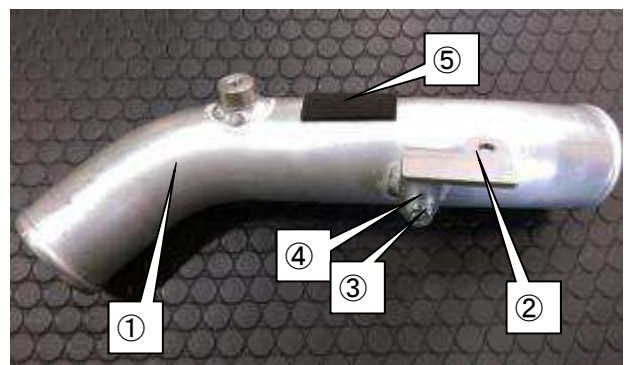

(2) Tighten ① I/C Inlet Pipe Bracket No.2 together with the factory A/C hose bracket as shown in the diagram on the right.

- ① I/C Inlet Pipe Bracket No.2 (P49)
- ② Cap Bolt M6 L20 (P82)
- ③ Large-diameter Washer M6 (P102)

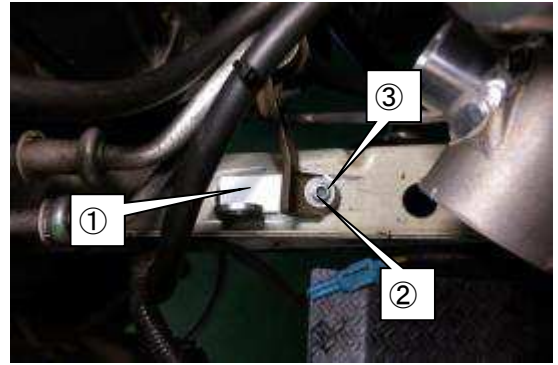

(3) Temporarily install the I/C Inlet Pipe No.1 to the installation position, and cut the portion "A" in the diagram that may come in contact with the pipe.

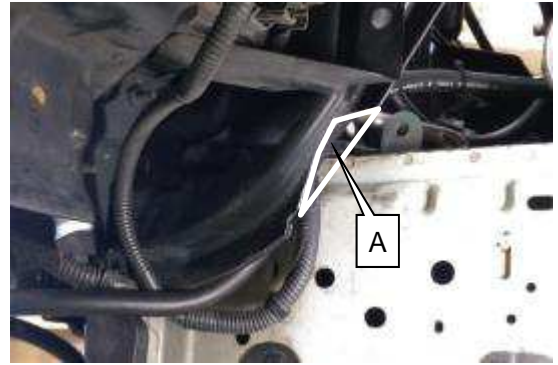

(4) Install ① I/C Inlet Pipe No.1 using the following provided parts.

- ② Cap Bolt M6 L20 (P82)
- ③ Flat Washer M6 (P101)
- ④ Cap Bolt M8 L15 (P84)
- ⑤ Flat Washer M8 (P104)

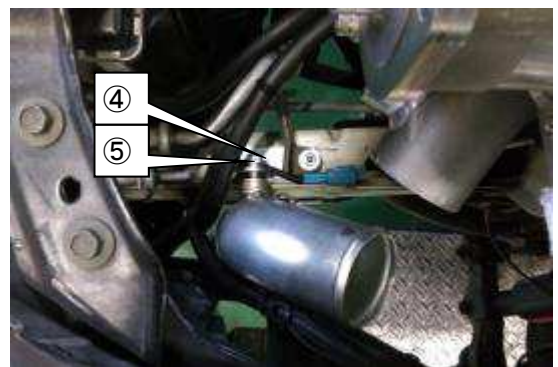
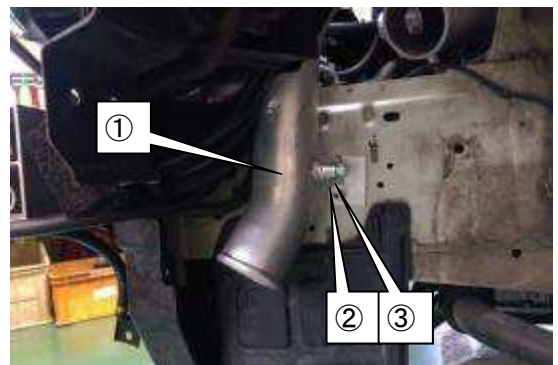

(5) Install ① I/C Inlet Pipe No.2 using the following provided parts.

- ① I/C Inlet Pipe No.2 (P40)
- ② Silicone Hose 70mm (P58)
- ③ Hose Band #44 (P62x3)
- ④ Silicone Hose 60mm-70mm (P59)
- ⑤ Hose Band #36 (P63)

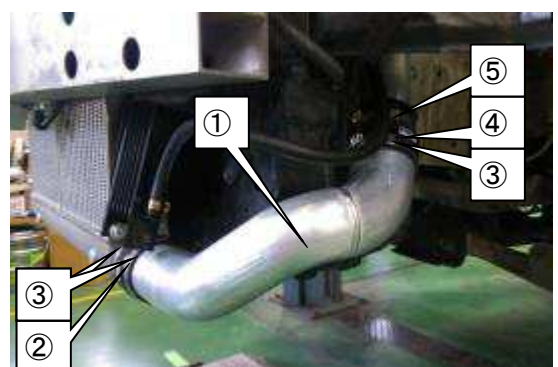

9. INSTALLATION OF SUCTION PIPE

Parts List

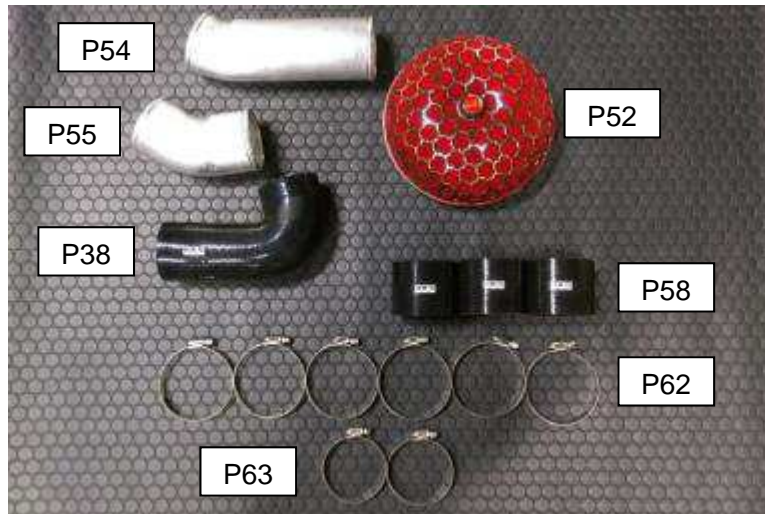

No.	Description	Qt
P38	I/C Inlet Hose	1
P52	Air Cleaner Assembly	1
P54	Suction Pipe No.2	1
P55	Suction Pipe No.3	1
P58	Silicone Hose 70mm	3
P62	Hose Band #44	6
P63	Hose Band #36	2

- (1) Shave off the portion of the factory left side inner fender circled in the diagrams on the right.



(2) Install the provided Silicone Hose 70mm to the GT Supercharger using the provided Hose Band #44.

- ①Silicone Hose 70mm (P58)
- ②Hose Band #44 (P62)

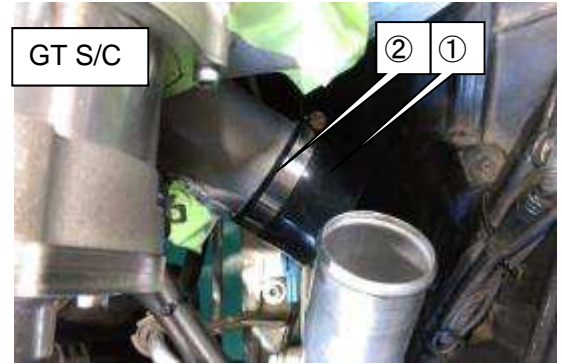

(3) Install ②Suction Pipe No.2 and ③Suction Pipe No.3 to ① Air Cleaner Assembly. Attach the provided Sponge Sheet as shown in the diagram on the right.

- ①Air Cleaner Assembly (P52)
- ②Suction Pipe No.2 (P54)
- ③Suction Pipe No.3 (P55)
- ④Silicone Hose 70mm (P58)
- ⑤Hose Band #44 (P62)
- ⑥Sponge Sheet (P69)

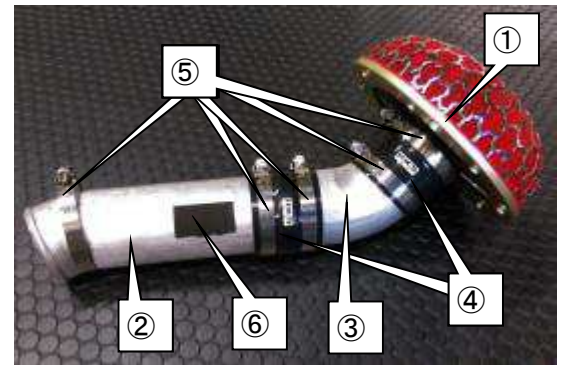

(4) Install the Suction Pipe assembled in (3) to the GT Supercharger.



(5) Attach the provided Sponge to the vehicle's body to prevent the Air Cleaner from direct contact with the body as shown in the diagram on the right.

- ①Sponge (P70)

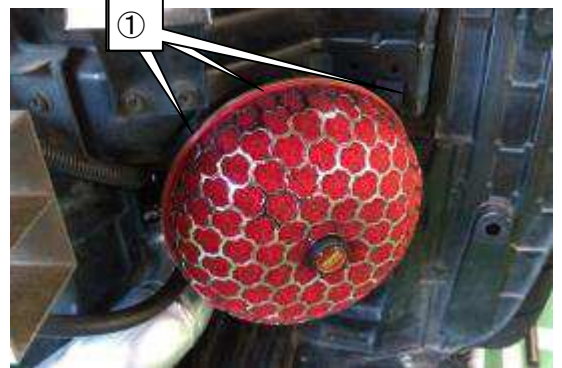

(6) Install ①I/C Inlet Hose using the provided Hose Band #36.

- ①I/C Inlet Hose (P38)
- ②Hose Band #36 (P63)

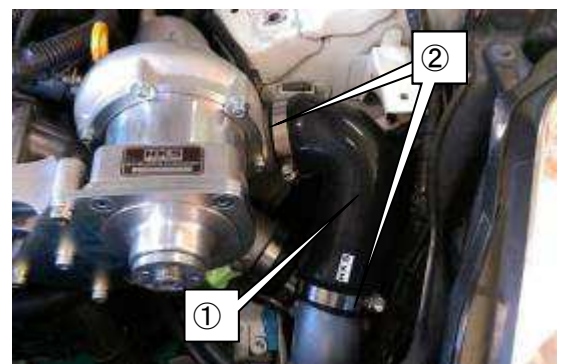

10. INSTALLATION OF INTERCOOLER OUTLET PIPE

Parts List

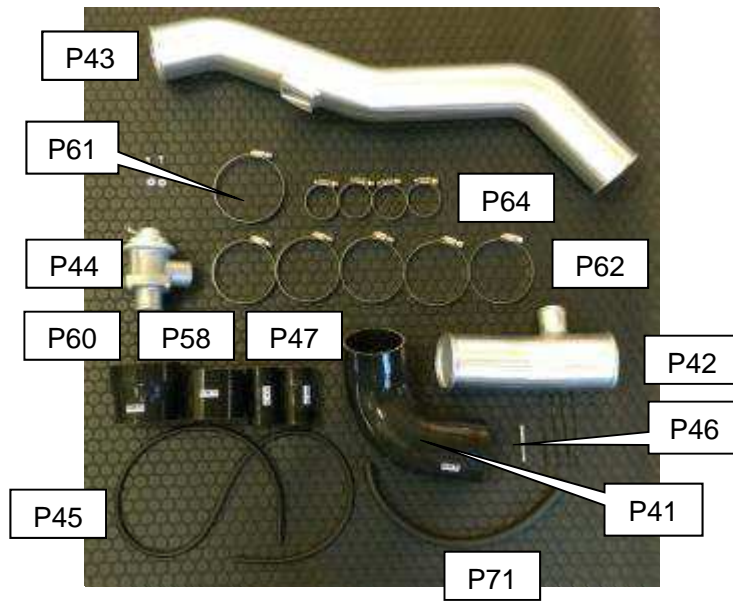

No.	Description	Qt
P41	I/C Outlet Hose	1
P42	I/C Outlet Pipe No.1	1
P43	I/C Outlet Pipe No.2	1
P44	Blow-off Valve	1
P45	Hose 4mm	1
P46	Joint Pipe 4mm-6mm	1
P47	Silicone Hose 35mm	2
P58	Silicone Hose 70mm	1
P60	Silicone Hose 70mm-80mm	1
P61	Hose Band #48	1
P62	Hose Band #44	5
P64	Hose Band #16	4
P71	Hose 6mm	1
P77	Cap Bolt M4 L12	2
P100	Spacer M4	2

(1) Cut ①Hose 4mm to 770mm. Install the 770mm hose to ②Joint Pipe 4mm-6mm.

- ①Hose 4mm (P45)
- ②Joint Pipe 4mm-6mm (P46)
- ③Tie Wrap (S) (P66)

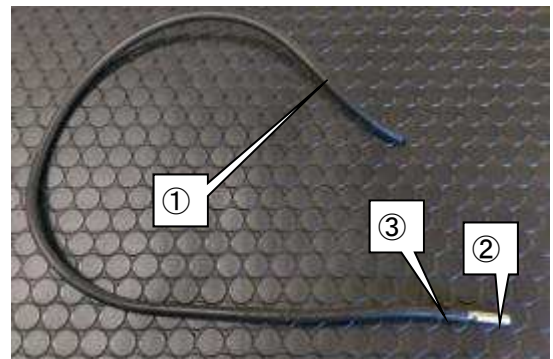

(2) Install ①Hose 4mm assembled in (1) to the intake manifold and secure the hose using the provided Tie Wrap (S).

- ②Tie Wrap (S) (P66)

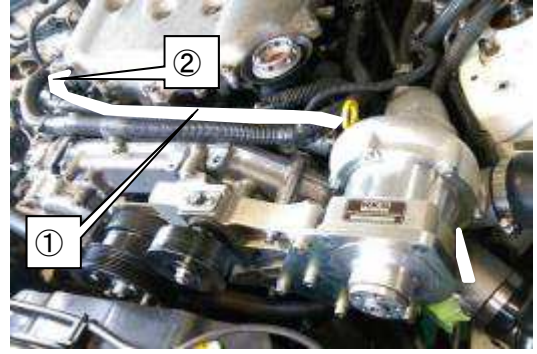

(3) Cut ②Hose 6mm to 350mm. Install the hose to ① hose installed in (2).

- ②Hose 6mm (P71)
- ③Tie Wrap (S) (P66)

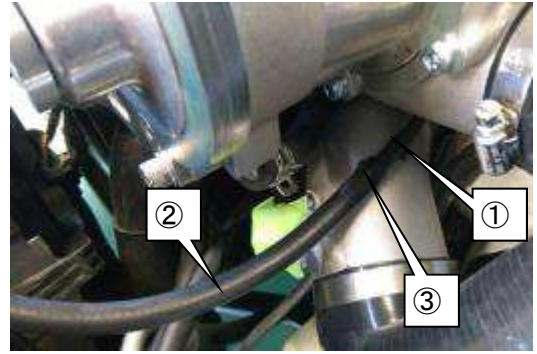

(4) Install ①I/C Outlet Hose.

- ①I/C Outlet Hose (P41)
- ②Hose Band #44 (P62)

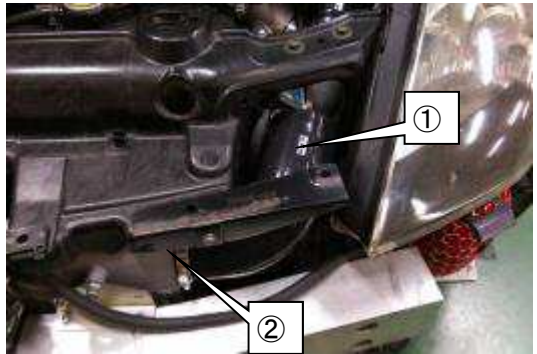

(5) Cut the Silicone Hose 35 mm to 50mm. Install ② Silicone Hose 35mm and ③ 50mm Silicone Hose 35mm to ①Blow-off Valve using the provided Hose Band #16 as shown in the diagram on the right.

- ①Blow-off Valve (P44)
- ②Silicone Hose 35mm (P47)
- ③50mm Silicone Hose 35mm (P47)
- ④Hose Band #16 (P64 x 4)



(6) Temporarily install ①Blow-off Valve assembled in (5) to ②Suction Pipe No.1.



(7) install ①I/C Outlet Pipe No.1 and the Blow-off Valve temporarily installed in (6).

- ①I/C Outlet Pipe No.1 (P42)
- ②Hose Band #44 (P62)



(8) Connect ②Hose 6mm installed in (3) to ①Blow-off Valve.

- ③Tie Wrap(S) (P66)

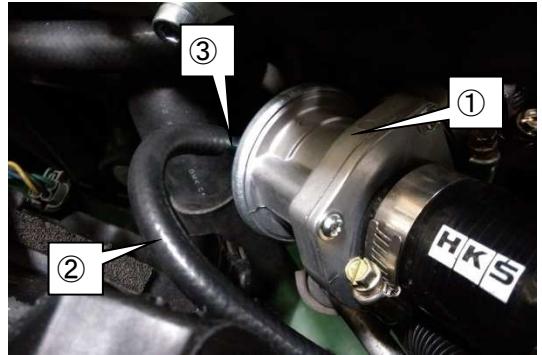

(9) Install ②Airflow Sensor removed in 1.(5) to ①I/C Outlet Pipe No.2.

- ①I/C Outlet Pipe No.2 (P43)
- ③Cap Bolt M4 L12 (P77)
- ④Spacer M4 (P100)

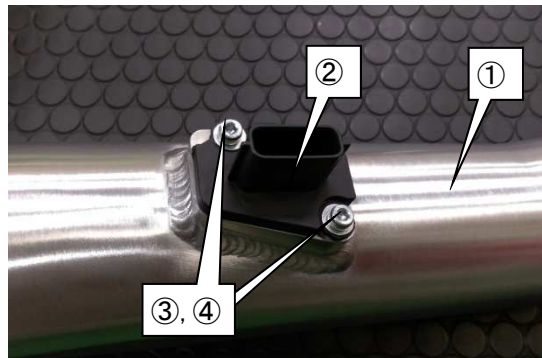

(10) Temporarily position ①I/C Outlet Pipe No.2, and attach the provided Sponge Sheet to where the I/C Inlet Hose may come in contact with the I/C Outlet Pipe No.2.

- ③Sponge Sheet (P69)

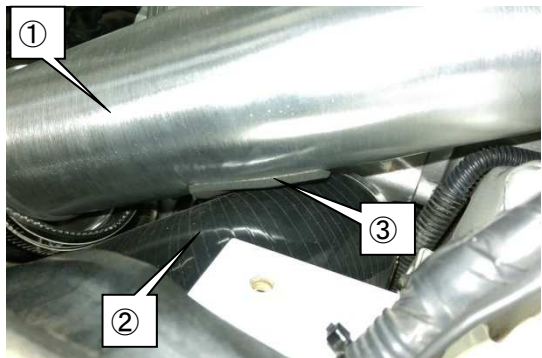

(11) Install ①I/C Outlet Pipe No.2. Make sure to install the airflow sensor coupler "A".

- ②Silicone Hose 70mm (P58)
- ③Hose Band #44 (P62)
- ④Silicone Hose 70mm-80mm (P60)
- ⑤Hose Band #48 (P61)

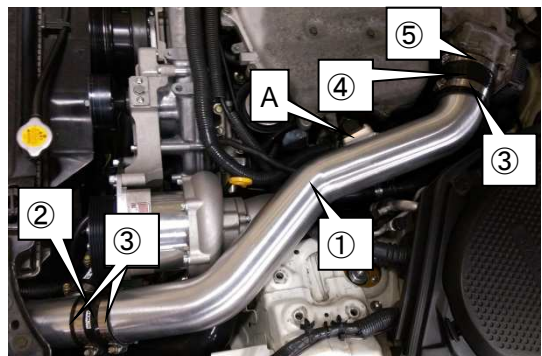

11. INSTALLATION OF SUPERCHARGER PULLEY & BELT

- (1) Check to make sure that ①Cap Bolt M6 L=18 x 4 have been properly tightened to 11.7-13.7 N·m (1.2-1.4 kgf·m) prior to installing the Belt 6PK1700.



CAUTION

- Use a torque wrench when tightening these bolts. Bolts may become damaged if tightened with insufficient or excessive torque, and Idler Pulley No.2 may slip off while driving.



- (2) Install the supercharger pulley using the provided Hexagon Cap Bolt. The supercharger pulley must be purchased separately and selected according to the target engine output.

Tightening Torque N·m(kgf·m)

$$T=10(1.02)$$

NOTE

- Refer to the table below for a belt matched with the pulley diameter 100mm and 110mm.

S/C Pulley Diameter	HKS Part Number	Belt	HKS Part Number
100mm	12999-AK005	7PK1060	24996-AK023
110mm	12999-AK006	7PK1080	—



- (3) Install ①belt.
- (4) Use a tension gauge when installing belts. Refer to the following Belt Tension Chart 1 and apply the “When New ①” tension spec. (Chart 1)

NOTE

- It is recommended to use a contactless belt tension gauge of Mitsubishi Doctor Tension Type-3 to measure the belt tension.

Tightening Torque N·m(kgf·m)

Factory Idler Pulley Nut (②):

$$T=31.4-38.2 \text{ N·m (3.2-3.9 kgf·m)}$$

Tensioner Pulley Nut (③) Torque Specs:

$$T=31.4-38.2 \text{ N·m (3.2-3.9 kgf·m)}$$

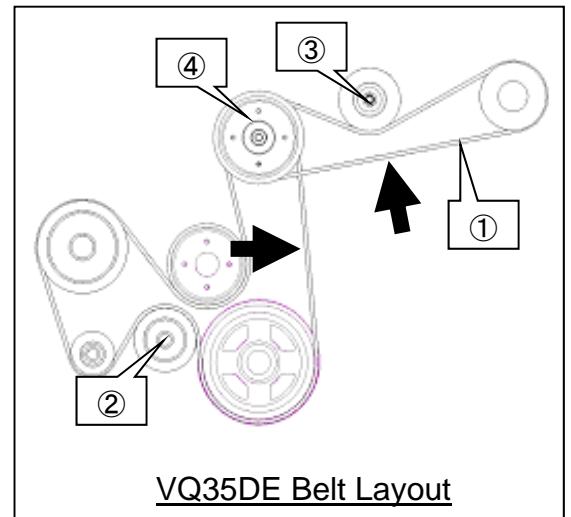

- (5) Tighten the four M6 bolts which were temporarily installed on ④idler pulley No.1.

Tightening Torque N·m(kgf·m)

$$T=5.9\sim 9.8(0.61\sim 0.99)$$

NOTE

Belt tension will settle at about 2-20 hours after installation. After the belt settles, re-measure the tension to make sure it matches the tension spec at “When Used ②”, from Chart 1 below. Adjust tension as necessary. Periodically monitor belt tension to make sure it is up to specifications.

Belt Tension Chart 1

Belt Spec	Belt Span	When New ① (N{kg})	When Used ② (N{kg})
6PK1700 (Crank Pulley)	295mm	950 (97.0)	760 (77.6)
7PK1060 or 1080 (Supercharger)	348mm	790 (80.6)	630 (64.3)

*1: Belt Span is the pulley's axis distance when measuring tension at the arrow sections in VQ35 Belt Layout. .

*2: Belt weight: 0.0188g / (1 rib x 1m length)



Caution

- Make sure the belt is correctly aligned with the grooves on the pulley. If it is not aligned, it may damage the belt.
- After installing the belt, adjust the tension. Rotate the crankshaft at least twice and re-adjust the tension to the indicated spec. This is to eliminate the inconsistency of the belt tension on the pulley.
- Make sure oil or coolant does not get on the belts.
- If the Supercharger belt is not set to the correct tension, the bonnet/hood and the tensioner pulley may come into contact with each other. Prior to closing the bonnet/hood, make sure there is at least 35mm of clearance as depicted in section ① of the below diagram.

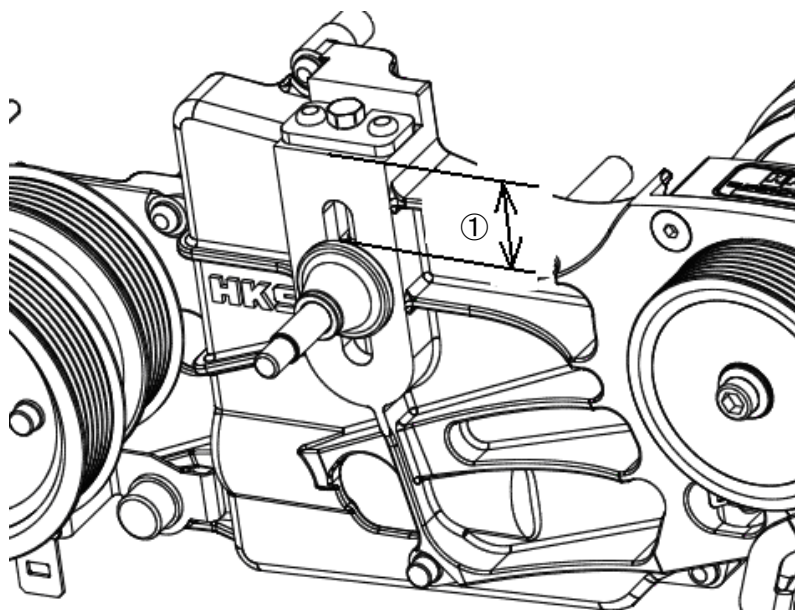

12. REINSTALLATION OF FACTORY PARTS

- (1) Re-connect the negative terminal of the vehicle's battery.
- (2) Sound the horn 2-3 times, and check that the horn fuse does not blow. If the fuse is blown, wiring for the horn may be incorrect.
- (3) Disconnect the negative terminal of the vehicle's battery.
- (4) Re-install the front bumper onto the vehicle.

-
- (5) Cut and remove the indicated sections of the engine cover that come into contact with the Supercharger Bracket and Pulley. Install the engine cover back onto the vehicle.
 - (6) Re-install the strut tower bar. Attach the provided Sponge Sheet to the portion where the bar comes into contact with the I/C Outlet Pipe No.2.

- Sponge Sheet (P69)



-
- (7) Re-install the engine under cover.

NOTE

- The engine under cover MUST be re-installed.

- (8) Re-connect the negative terminal of the vehicle's battery.

-
- (9) Ensure that the engine operation environment is properly managed using F-CON iS, F-CON V Pro, or a similar engine management tool.

13. FILLING TRACTION FLUID

Parts List

		No.	Description	Qt.
		P4	Traction Fluid	1

P4

NOTE

- ***This step MUST be conducted prior to starting the engine. Starting the engine without first adding Traction Oil can lead to damage to the Supercharger Assy.***
- ***Do not allow foreign objects to mix with the Traction Oil. The internal components of the Supercharger Assy are very precise and exact; foreign objects mixed with Traction Oil can lead to damage to the Supercharger Assy.***

(1) Check to make sure that there are no foreign objects in the Traction Oil Tank. Add 500cc of Traction Oil to the fluid tank as described below:

※ Add 350cc of Traction Oil to the tank, let the oil level of the tank lower, and add another 150cc of Traction Oil (up to the dotted line in diagram on the right).

- Traction Oil (P4)

(2) Close the cap of the fluid tank.

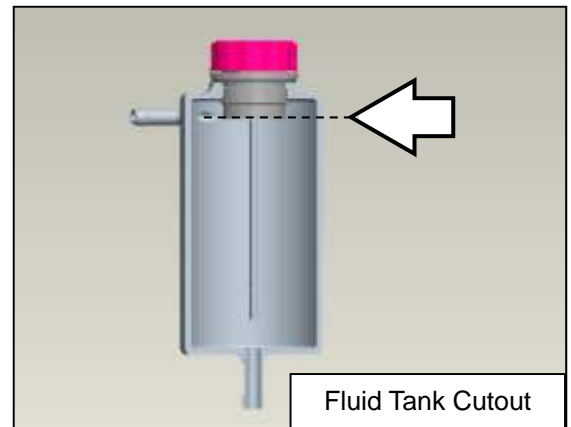

14. CONFIRMATION AFTER INSTALLATION

Check the following after the installation process is complete.

(1) Check off the following before starting the engine:

	Verify	Check
1	Make sure Traction Oil Piping is correct.	
2	Make sure the wiring harnesses and installed components are not in contact with other parts of the vehicle.	
3	Make sure the harness is not pinched at any place	
4	Make sure the belt is tightened to spec	
5	Make sure bolts and the bolt that secures the pulley are tightened properly.	
6	Make sure traction oil is at marking level of the level gauge.	
7	Make sure pipes and hoses are routed and connected correctly.	
8	Make sure hoses are not twisted or bent.	
9	Make sure all hose bands are tight.	
10	Make sure all bolts and nuts are tightened.	
11	Make sure all installed components are secured.	
12	Make sure the negative cable terminal is securely attached to the battery.	
13	Make sure the level gauge for the engine oil is between H – L.	

(2) Prepare 80cc of Traction Oil in a beaker or small container, and start the engine.

(3) Immediately after starting the engine, perform the following:

1. Check to make sure that the oil level starts to decline, and then increase again.
2. Add oil from the 80cc beaker or small container, so that the Oil Tank level does not get empty. Also make sure that the Oil Tank does not overflow.

※ There may be some unusual or unpleasant noises emanating from the Supercharger Assy after starting the engine. This is normal, and this noise will go away after the Traction Oil warms up (approximately 2-3 minutes).

(4) Start the engine and perform the following checks after the engine reaches normal operating temperature:

NOTE

- Do not raise the engine RPM while the engine is warming up; let it idle.

	Verify:	Check
1	Make sure the Traction Oil returns to the Oil Tank.	
2	Make sure there are no leaks in the fuel, Traction Oil, coolant, or air.	
3	Make sure there is no excessive stress on harnesses, fuel lines, and hoses.	
4	Make sure the installed parts are not hitting each other.	

- (5) After verifying the above items, raise and keep the RPM stable at 2000RPM for 10 seconds. Immediately shut off the engine and check the Traction Oil level. The Oil Level needs to be at level ① indicated in the diagram below. If it is lower, add Traction Oil as necessary.
- (6) Make sure to close the cap after adding the Traction Oil to the tank.

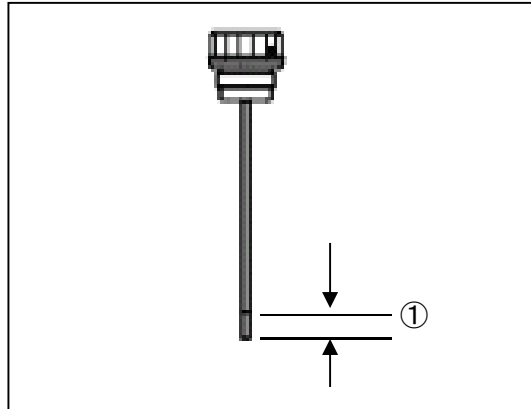

- ※ If there is excess Traction Oil remaining in the bottle, replace the cap on the bottle and store in a safe location. Always store excess Traction Oil in the original bottle.



HKS Co., Ltd.

7181 Kitayama, Fujinomiya, Shizuoka 418-0192, Japan

<http://www.hks-power.co.jp/>